



**MECHANICAL EXTRACT VENTILATION**  
**AND HEAT RECOVERY**





**VORTICE S.p.A.** is now part of a multinational group, **the VORTICE GROUP**, which operates through its own companies or local distributors in over 90 countries worldwide and has a rich product portfolio that guarantees air quality and climate comfort. The headquarters of VORTICE S.p.A are in Tribiano (Milan).



The VORTICE GROUP also includes:

[1] **VORTICE LIMITED**, English branch of VORTICE S.p.A established in 1977 and based in Burton on Trent.

[2] **VORTICE INDUSTRIAL**, born from the acquisition in 2010 of Loran srl, based in Isola della Scala (VR).

[3] **VORTICE Ventilation System**, a company inaugurated in 2013 with headquarters in Changzhou, China.

[4] **VORTICE Latam**, based in Alajuela in Costa Rica, established in 2012.

[5] **CASALS VENTILACIÓN AIR INDUSTRIAL S.L.**, a historic Spanish brand, based in Sant Joan de les Abadesses, Girona, acquired in 2019.



# TABLE OF CONTENTS

04	<b>VORT NOTUS RANGE</b> Axial extractor fans for continuous ventilation	78	<b>WDG63 - WDG75 - WDG35 SYSTEM COMPONENTS</b>
08	<b>VORT PLATT RANGE</b> Centralised mechanical ventilation unit	96	<b>WDG SYSTEM 35</b>
12	<b>VORT PENTA RANGE</b> Decentralized mechanical ventilation unit	110	<b>VMC SYSTEM</b>
16	<b>VORT MONO RANGE</b> Decentralized heat recovery units	116	<b>VORT PLENUM COMPONENTS</b>
30	<b>VORT HR NETI RANGE</b> Wall-mounted heat recovery unit	120	<b>GENERIC COMPONENTS</b>
34	<b>VORT HR AVEL RANGE</b> Wall-mounted heat recovery units	124	<b>FILTER BOXES AND HEATERS</b>
44	<b>VORT PROMETEO PLUS RANGE</b> Heat recovery unit	128	<b>NOISE ATTENUATOR</b>
50	<b>VORT INVISIBLE MINI RANGE</b> Heat recovery unit for false ceiling	129	<b>BATTERIES</b>
56	<b>VORT HRI FLAT RANGE</b> Heat recovery units for false ceiling	134	<b>REMOTE CONTROL PANEL</b>
62	<b>VORT PHANTOM RANGE</b> Heat recovery units for false ceiling	136	<b>REGULATORS AND CONTROLLERS</b>
70	<b>VORT HRI DH RANGE</b> Heat recovery units with dehumidification function		

# VORT NOTUS RANGE

AXIAL EXTRACTOR FANS FOR CONTINUOUS VENTILATION

**CENTRALIZED VENTILATION**

**WALL MOUNTED**

**UP TO 60/90 M<sup>2</sup>**

Wall and ceiling axial extractor fans compatible with in-line installation. Thanks to the very low consumption of the EC (brushless) motor used, VORT NOTUS fans are ideal for the continuous ventilation of small and medium-sized residential and commercial premises whose layout allows direct or short-ducted discharge.



- Self-extinguishing polypropylene casing.
- DC-EC motor with very low electrical consumption (max 6.4 W), constant flow operation.
- Built-in adjustable timer (3'-20'), built-in humidity control sensor (adjustable from 60% to 90%).
- Degree of protection IPX4.
- Power supply 220-230 V - 50 Hz.

## PERFORMANCE AND ABSORPTION

4

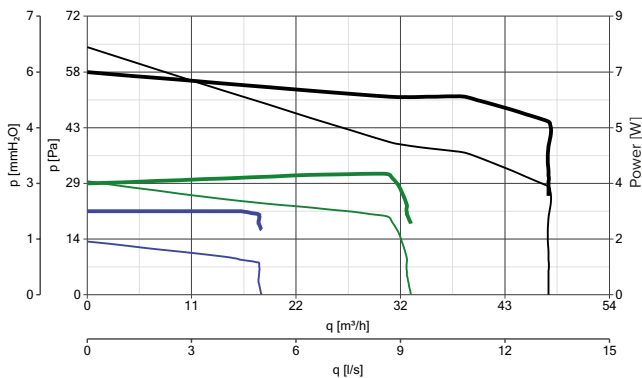

## TECHNICAL DATA

PRODUCTS	CODE	Nom. Ø (mm)	(m <sup>3</sup> /h)	(W)	(PA)	Lp [db(A)] 3m
VORT NOTUS	11177	100	42	6.4	86.3	17.3
VORT NOTUS T-HCS	11903	100	42	2.8	86.3	17.3

### CONSUMPTION CURVES

— max  
— avg  
— min

### PERFORMANCE CURVES

— max  
— avg  
— min

## DIMENSIONS

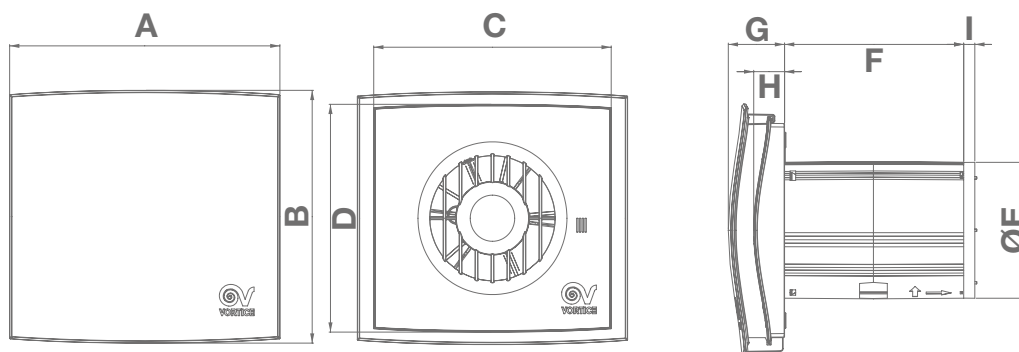

PRODUCTS	CODE	A	B	C	D	ØE	F	G	H	I
VORT NOTUS	11177	194.6	182	171	164	97.8	129	40.5	22.2	8
VORT NOTUS T-HCS	11903	194.6	182	171	164	97.8	129	40.5	22.2	8

Dimensions in mm



## ENERGY DATA

	UNIT OF MEASUREMENT	VORT NOTUS VORT NOTUS T-HCS
MANUFACTURER'S NAME OR TRADE NAME	-	VORTICE
CLASS OF SPECIFIC ENERGY CONSUMPTION FOR TEMPERATE CLIMATE	-	NA*
SPECIFIC ENERGY CONSUMPTION SEC (TEMPERATE CLIMATE)	kWh/m <sup>2</sup> year	-6.2
SPECIFIC ENERGY CONSUMPTION SEC (COLD CLIMATE)		-19.5
SPECIFIC ENERGY CONSUMPTION SEC (WARM CLIMATE)		1.5
DECLARED TYPE OF THE VENTILATION UNIT	-	UVR-U**
DRIVE TYPE	-	NA*
HRS HEAT EXCHANGER TYPE	-	absent
THERMAL EFFICIENCY OF HEAT RECOVERY AT THE HRS REFERENCE FLOW RATE	%	NA*
MAXIMUM FLOW RATE	m <sup>3</sup> /h	43
TOTAL ELECTRIC POWER ABSORBED BY THE FAN AT MAXIMUM FLOW RATE	w	3.5
NOISE LEVEL	LWA [dB(A)]	32.4
REFERENCE FLOW RATE	m <sup>3</sup> /s	0.0084
REFERENCE PRESSURE DIFFERENCE	Pa	62
SPI****	W/(m <sup>3</sup> /h)	0.22591
CTRL CONTROL FACTOR	-	1
CONTROL TYPE	-	manual
MAXIMUM PERCENTAGE OF INTERNAL LEAKAGE	%	NA*
MAXIMUM PERCENTAGE OF EXTERNAL LEAKAGE	%	NA*
MIXING RATE	-	NA*
VISUAL FILTER SIGNAL POSITION AND DESCRIPTION	-	na*
AIR FLOW SENSITIVITY TO PRESSURE VARIATIONS AT ± 20 PA	-	NA*
INDOOR/OUTDOOR AIR TIGHTNESS	m <sup>3</sup> /h	NA*
AEC ANNUAL ELECTRICITY CONSUMPTION	kWh of electricity/year	311
TEMPERATE AHS ANNUAL HEATING SAVING	kWh of primary energy/year	1397
COLD AHS ANNUAL HEATING SAVING		8901
WARM AHS ANNUAL HEATING SAVING		632

\* NA: Not applicable. \*\* UVR-U: Residential Ventilation Unit - Unidirectional. \*\*\* VM: Multiple speeds. VSD: Variable Speed Drive.

\*\*\*\* SPI: Specific power input.

**VORT NOTUS RANGE**  
AXIAL EXTRACTOR FANS FOR CONTINUOUS VENTILATION

## TECHNICAL FEATURES

- **2 models** with a nominal diameter of 100 mm, also in version with timer and humidistat.
- **White plastic resin construction** (ABS), resistant to impact and aging due to exposure to the sun ("UV resistant").
- **EC (brushless) motors**, thermally protected, with external rotor, with shafts mounted on ball bearings to guarantee prolonged continuous service (at least 30,000 h) at the maximum plate temperature, featuring very low consumption and capable of delivering 3 different flow levels, 2 of which can be set as an alternative upon installation.
- Helical impellers with wing profile blades **optimised to combine high efficiency with low noise emissions.**
- T-HCS model **equipped with an electronic board with relative humidity (RH)** sensor which automatically switches from the minimum flow previously set to the maximum flow. The board integrates an electronic timer that restores operation at minimum speed, after the return of the RH below the threshold value, with a delay that can be set during installation in the 3'-20' interval (default setting 3').
- Performance and safety certified by third parties (Ⓢ and BRE).
- **Degree of protection from dust and water:** IPX4 (suitable for Zone 1 installation).
- **Electrical insulation class:** II (earthing not required).

6

## TECHNICAL DATA

PRODUCTS	CODE	V~50 HZ	W min/max	A min/max	MAX FLOW RATE		MAX PRESSURE		Lp dB(A)* 3m min/max	°C* MAX	KG
					m <sup>3</sup> /h min/max	l/s min/max	mmH <sub>2</sub> O min/max	Pa min/max			
VORT NOTUS	11903	220-230	1.5 2.8	0018 0025	11.7 42.0	3.3 11.7	2.4 8.8	23.5 86.3	10.1 17.3	50	0.80
VORT NOTUS T-HCS	11177	220-230	2.1 6.4	0028 0037	11.7 42.0	3.3 11.7	2.4 8.8	23.5 86.3	10.1 17.3	50	0.80

\* Acoustic pressure measured from 3 m in free field, in compliance with ISO 3741.

\*\* Maximum continuous operating temperature of the product.



## DETAILS

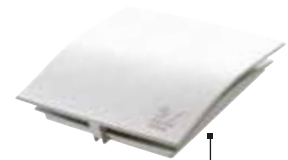
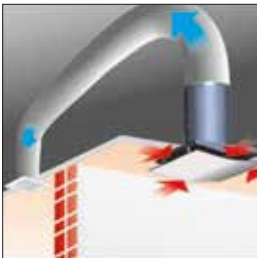

Reduced thickness (approx. 40 mm), which minimizes the aesthetic impact.

Reliability over time: the life of the motors is guaranteed for at least 30,000 h of continuous operation at the maximum certified temperature.

**LONG LIFE** 30.000 h

Strong protection from water, suitable for use in Zone 1 of bathrooms and in the presence of high humidity levels.

# VORT PLATT RANGE

CENTRALISED MECHANICAL VENTILATION UNIT

C

FALSE CEILING CENTRALISED

VENTILATION

Unit for simple-flow centralised mechanical ventilation with reduced thickness. Installed in a false ceiling or in the attic, it extracts stale air from service rooms and facilitates the return of fresh external air through openings appropriately positioned in the residential rooms. A pair of relative humidity sensors enable the automatic adjustment of the performance provided to the actual needs of the moment.



- Casing of zinc-coated metal sheet and flanges of ABS, centrifugal-axial motor-fan unit mounted on ball bearings.
- Low consumption DC-EC single-phase motor, absorption 12/50 W.
- Return spigot Ø125mm, intake spigots 3 x Ø80mm + 1 x Ø125mm.
- Class II insulation.
- Integrated adjustable timer (max 30').
- Degree of protection IPX4.

## PERFORMANCE AND ABSORPTION

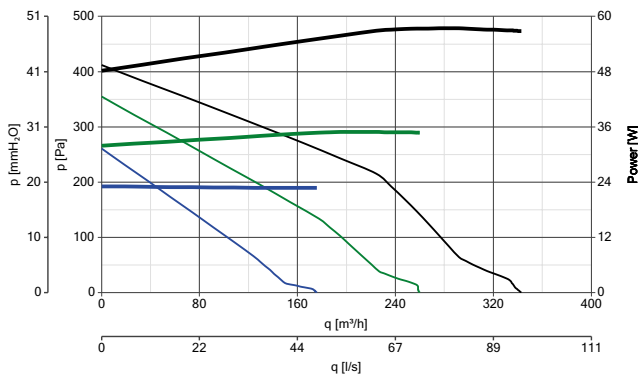

## TECHNICAL DATA

PRODUCT	CODE	Nom. Ø (mm)	(m <sup>3</sup> /h)	(W)	(PA)	Lp [db(A)] 3m
VORT PLATT HCS	12108	80-125	343	56	411.7	34.9

CONSUMPTION CURVES

— max  
— avg  
— min

PERFORMANCE CURVES

— max  
— avg  
— min

## DIMENSIONS

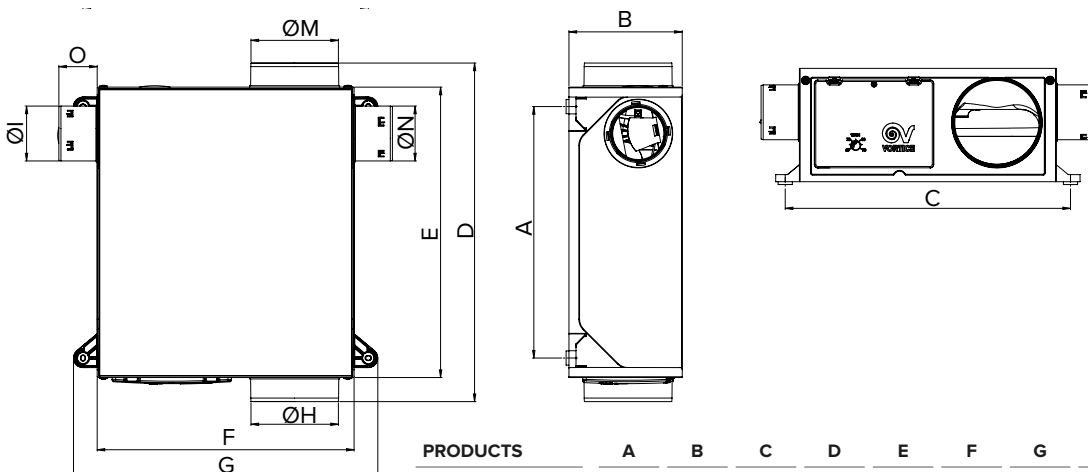

Dimensions in mm

PRODUCTS	A	B	C	D	E	F	G	ØH	ØI	ØM	ØN	O
VORT PLATT HCS	355	160	403	478	410	363	430	124.5	77.5	124.5	77.5	45





## ENERGY DATA

	UNIT OF MEASUREMENT	VORT PLATT HCS
MANUFACTURER'S NAME OR TRADE NAME	-	VORTICE
CLASS OF SPECIFIC ENERGY CONSUMPTION FOR TEMPERATE CLIMATE	-	C
SPECIFIC ENERGY CONSUMPTION SEC (TEMPERATE CLIMATE)	kWh/m <sup>2</sup> year	-25.4
SPECIFIC ENERGY CONSUMPTION SEC (COLD CLIMATE)		-52.4
SPECIFIC ENERGY CONSUMPTION SEC (WARM CLIMATE)		-9.9
DECLARED TYPE OF THE VENTILATION UNIT	-	UVR-U**
DRIVE TYPE	-	VM***
HRS HEAT EXCHANGER TYPE	-	absent
THERMAL EFFICIENCY OF HEAT RECOVERY AT THE HRS REFERENCE FLOW RATE	%	NA*
MAXIMUM FLOW RATE	m <sup>3</sup> /h	280
TOTAL ELECTRIC POWER ABSORBED BY THE FAN AT MAXIMUM FLOW RATE	w	57.6
NOISE LEVEL	LWA [dB(A)]	57
REFERENCE FLOW RATE	m <sup>3</sup> /s	0.05
REFERENCE PRESSURE DIFFERENCE	Pa	100
SPI****	W/(m <sup>3</sup> /h)	0.18
CTRL CONTROL FACTOR	-	0.65
CONTROL TYPE	-	local premise
MAXIMUM PERCENTAGE OF INTERNAL LEAKAGE	%	NA*
MAXIMUM PERCENTAGE OF EXTERNAL LEAKAGE	%	7.4
MIXING RATE	-	NA*
VISUAL FILTER SIGNAL POSITION AND DESCRIPTION	-	NA*
AIR FLOW SENSITIVITY TO PRESSURE VARIATIONS AT ± 20 PA	-	NA*
INDOOR/OUTDOOR AIR TIGHTNESS	m <sup>3</sup> /h	NA*
AEC ANNUAL ELECTRICITY CONSUMPTION	kWh of electricity/year	117
TEMPERATE AHS ANNUAL HEATING SAVING	kWh of primary energy/year	2830
COLD AHS ANNUAL HEATING SAVING		5536
WARM AHS ANNUAL HEATING SAVING		1280

\* NA: Not applicable. \*\* UVR-U: Residential Ventilation Unit - Unidirectional. \*\*\* VM: Multiple speeds. VSD: Variable Speed Drive.

\*\*\*\* SPI: Specific power input.

**VORT PLATT RANGE**  
CENTRALISED MECHANICAL VENTILATION UNIT

## TECHNICAL FEATURES

- **1 model.**
- Cover of **zinc-coated metal sheet.**
- Rear flange of black plastic resin (ABS) **resistant to impact and aging** due to sun exposure ("UV resistant") including anchoring brackets for target surface and the position, protected by a black ABS sealed cover, of the terminals for connection to the electricity grid.
- **4 intake spigots**, three of 80 mm nominal diameter of and one of 125 mm and 1 discharge nozzle of 125 mm nominal diameter, on the lateral surface of the product.
- **3-speed AC motor**, thermally protected, with shaft mounted on ball bearings, guarantees prolonged service (at least 30,000 h) at the maximum rated temperature; speed selector and ON/OFF control available as an option.
- Impeller, of the centrifugal type with backward curved blades, **made of plastic resin loaded with glass fibers**, to combine dimensional stability, strength, and resistance to aggressive agents.
- Relative humidity sensors, electronically managed, with **adjustable threshold upon installation.**
- **2 connection sleeves to the intake pipes made of plastic resin** (PP), designed for interlocking in the 80-mm spigots. Equipped with special mylar valves to maintain the extracted flow rate at 30 m<sup>3</sup>/h, regardless of pressure drops and the number of connected rooms.
- 1 cap with 80 mm diameter, for closing the spigot that may not be used, supplied as standard.
- **Safety certified by a third party** (CE).
- **Electrical insulation class:** II (earthing not required).

## TECHNICAL DATA

PRODUCTS	CODE	V~50 HZ	W		RPM	MAX FLOW RATE		MAX PRESSURE		Lp dB(A)* 3m max	°C* MAX	KG
			min/max	min/max		m <sup>3</sup> /h min/max	l/s min/max	mmH <sub>2</sub> O min/max	Pa min/max			
VORT PLATT HCS	12108	230	23 56	0.21 0.25	1300 2610	176 343	48.8 95.2	26.6 41.9	261 411.7	34.9	60	5.4

\* Acoustic pressure measured from 3 m in free field, in compliance with ISO 3741.

\*\* Maximum continuous operating temperature of the product.

## ACCESSORIES

MODELS	DESCRIPTION	CODE	VORT PLATT HCS code 12108
	FLOW REGULATOR	15 m <sup>3</sup> /h	✓
		30 m <sup>3</sup> /h	



## DETAILS



The internal duct design guarantees high performance, low consumption, and lower noise levels.

Light and at the same time robust construction.

Reliability over time: the life of the motor is guaranteed for at least 30,000 h of continuous operation at the maximum certified temperature.

**LONG LIFE** 30.000 h

# VORT PENTARANGE

CENTRALISED MECHANICAL VENTILATION UNIT



**CENTRALISED VENTILATION**

**FALSE CEILING**

Unit for simple-flow centralised mechanical ventilation. Installed in a false ceiling or in the attic, it extracts stale air from service rooms and facilitates the return of fresh external air through openings appropriately positioned in the residential rooms. A pair of relative humidity sensors enables the automatic adjustment of the performance to the actual needs of the moment.



- Centralised unit for single-flow residential MCV for up to 6 rooms.
- ABS casing, centrifugal-axial motor-fan unit mounted on ball bearings.
- Low consumption single-phase DC-EC motor.
- Return spigot Ø125mm, intake spigots 5 x Ø80mm + 1 x Ø125mm.
- Class II insulation.
- Integrated adjustable timer (max 30').
- Degree of protection IPX4.
- Integrated relative humidity sensor.

12

## PERFORMANCE AND ABSORPTION

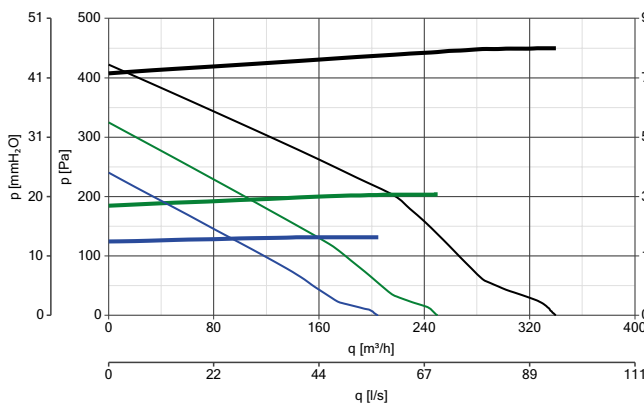

## TECHNICAL DATA

PRODUCT	CODE	Nom. Ø (mm)	(m³/h)	(W)	(PA)	Lp [dB (A)] 3m
VORT PENTA HCS	12103	125	340	73	421.9	31.9

CONSUMPTION CURVES  
 — max  
 — avg  
 — min

PERFORMANCE CURVES  
 — max  
 — avg  
 — min

## DIMENSIONS

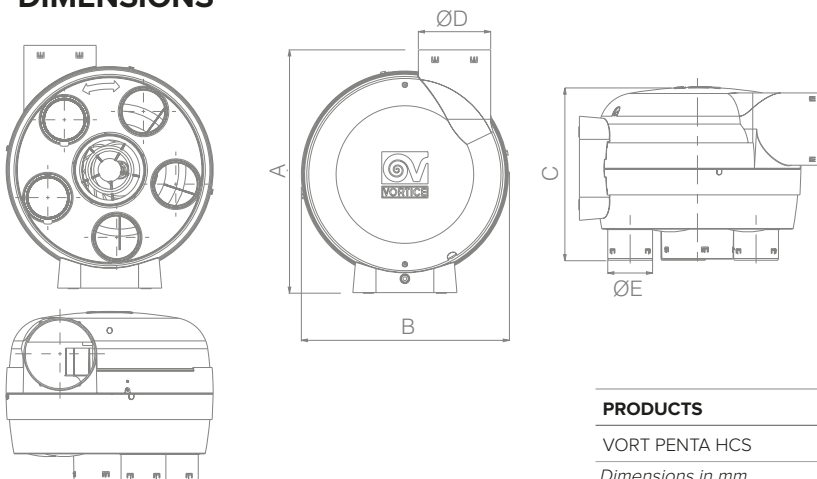

PRODUCTS	A	B	C	ØD	ØE
VORT PENTA HCS	420	358	300	125	77.5

Dimensions in mm



Light and at the same time robust construction.

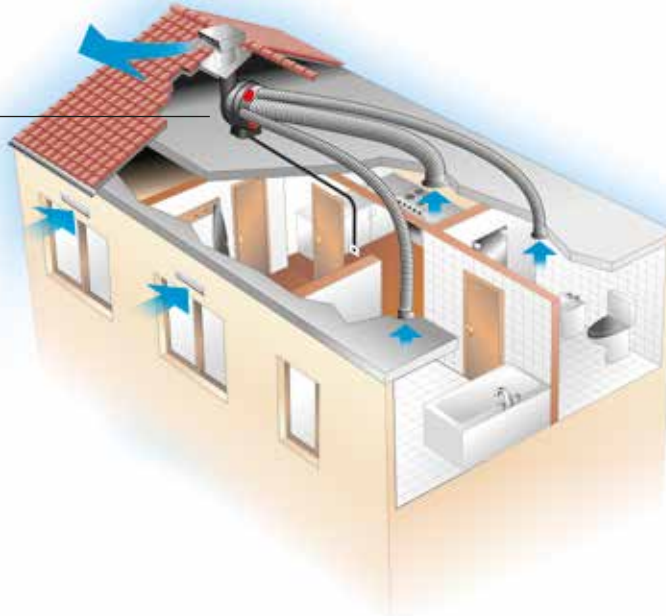

## ENERGY DATA

	UNIT OF MEASUREMENT	VORT PENTA HCS
MANUFACTURER'S NAME OR TRADE NAME	-	VORTICE
CLASS OF SPECIFIC ENERGY CONSUMPTION FOR TEMPERATE CLIMATE	-	C
SPECIFIC ENERGY CONSUMPTION SEC (TEMPERATE CLIMATE)	kWh/m <sup>2</sup> year	-25,124
SPECIFIC ENERGY CONSUMPTION SEC (COLD CLIMATE)		-52,187
SPECIFIC ENERGY CONSUMPTION SEC (WARM CLIMATE)		- 9,621
DECLARED TYPE OF THE VENTILATION UNIT	-	UVR-U**
DRIVE TYPE	-	VM***
HRS HEAT EXCHANGER TYPE	-	absent
THERMAL EFFICIENCY OF HEAT RECOVERY AT THE HRS REFERENCE FLOW RATE	%	NA*
MAXIMUM FLOW RATE	m <sup>3</sup> /h	268
TOTAL ELECTRIC POWER ABSORBED BY THE FAN AT MAXIMUM FLOW RATE	w	80
NOISE LEVEL	LWA [dB(A)]	50
REFERENCE FLOW RATE	m <sup>3</sup> /s	0,052
REFERENCE PRESSURE DIFFERENCE	Pa	90
SPI****	W/(m <sup>3</sup> /h)	0,193
CTRL CONTROL FACTOR	-	0.65
CONTROL TYPE	-	local premise
MAXIMUM PERCENTAGE OF INTERNAL LEAKAGE	%	NA*
MAXIMUM PERCENTAGE OF EXTERNAL LEAKAGE	%	9.6
MIXING RATE	-	NA*
VISUAL FILTER SIGNAL POSITION AND DESCRIPTION	-	NA*
AIR FLOW SENSITIVITY TO PRESSURE VARIATIONS AT ± 20 PA	-	NA*
INDOOR/OUTDOOR AIR TIGHTNESS	m <sup>3</sup> /h	NA*
AEC ANNUAL ELECTRICITY CONSUMPTION	kWh of electricity/year	127
TEMPERATE AHS ANNUAL HEATING SAVING	kWh of primary energy/year	2830
COLD AHS ANNUAL HEATING SAVING		5536
WARM AHS ANNUAL HEATING SAVING		1280

\* NA: Not applicable. \*\* UVR-U: Residential Ventilation Unit - Unidirectional. \*\*\* VM: Multiple speeds. VSD: Variable Speed Drive.

\*\*\*\* SPI: Specific power input.

**VORT PENTA RANGE**  
CENTRALISED MECHANICAL VENTILATION UNIT

## TECHNICAL FEATURES

- **1 model.**
- **Black plastic resin (ABS) casing resistant to impacts** and aging due to sun exposure ("UV resistant"); the lower surface integrates 6 intake spigots, 5 with 80 mm nominal diameter and one with 125 mm nominal diameter. The discharge nozzle, with 125 mm nominal diameter, is on the lateral surface. On the upper surface, protected by a sealed black ABS cover.
- **Black plastic resin (ABS) bracket**, sliding along the side of the products and integrating the holes for fixing the appliance to the target surface
- **3-speed AC motor**, thermally protected, with shaft mounted on ball bearings, guarantees prolonged service (at least 30,000 h) at the maximum rated temperature.
- Impeller, of the centrifugal type with backward curved blades, made of plastic resin loaded with glass fibers, to combine **dimensional stability, strength, and resistance to aggressive agents.**
- **Relative humidity sensors**, electronically managed, with threshold adjustable upon installation.
- 2 sleeves connecting to the intake pipes of plastic resin (PP), designed for interlocking in the 80-mm spigots, integrating special mylar valves to maintain the extracted flow rate at 30 m<sup>3</sup>/h, regardless of pressure drops and the number of connected rooms.
- **4 caps** with 80 mm diameter, for closing any spigot that may not be used, supplied as standard.
- **Safety certified by a third party** (CE)
- **Degree of protection from dust and water:** IPX4.
- **Electrical insulation class:** II (earthing not required).

14

## TECHNICAL DATA

PRODUCTS	CODE	V~50 HZ	W		RPM	MAX FLOW RATE		MAX PRESSURE		Lp dB(A)* 3m min/max	°C* MAX	KG
			min/max	A min/max		m <sup>3</sup> /h min/max	l/s min/max	mmH <sub>2</sub> O min/max	Pa min/max			
VORT PENTA HCS	12103	230	21 73	0.19 0.34	1245 2160	205 340	59.9 94.4	24.4 43.0	240.1 421.9	- 31.9	40	4.4

\* Acoustic pressure measured from 3 m in free field, in compliance with ISO 3741.

\*\* Maximum continuous operating temperature of the product.

## ACCESSORIES

MODELS	DESCRIPTION	CODE	VORT PENTA HCS code 12103
	FLOW REGULATOR	15 <sup>3</sup> /h	✓
		30 <sup>3</sup> /h	



## DETAILS



Suitable for installation in false ceilings or attics, they are designed for suspended mounting using a cable supplied as standard.

Reliability over time: the life of the motor is guaranteed for at least 30,000 h of continuous operation at the maximum certified temperature.

**LONG LIFE** 30.000 h



The internal duct design guarantees high performance, low consumption, and reduced noise levels.



Alternatively, an integrated rotating bracket is available, which facilitates the installation of the fan in any position, ensuring the correct arrangement for the needs of the system.

# VORT MONORANGE

DECENTRALISED HEAT RECOVERY UNITS

**A**

**CENTRALISED WALL**

**VENTILATION**

Ventilation units with heat recovery specifically designed for air exchange in newly built or renovated residential and commercial premises, featuring high levels of thermal insulation. Can be installed in perimeter walls between 260 mm and 700 mm thick. Available in the manual control version, in the variants with controls on the machine and the version with remote control and relative humidity, temperature, and ambient light sensors.



- High-efficiency 90% heat exchanger, made of ceramic material of the hexagonal cell type to maximise the heat exchange surface.
- Casing in expanded polypropylene (EPP), designed for housing in a hole, with (100/160 mm) nominal diameter, drilled in the target perimeter wall.
- EC motor fans, to ensure very low consumption.
- HCS models are supplied with remote control.
- Class II insulation.
- Washable and easily accessible G3 filters.

16

**VORT HRW 40 MONO EVO**  
CODE 12435 Ø160 mm  
WITH ON-BOARD CONTROLS  
**VORT HRW 40 MONO EVO HCS**  
CODE 12437 Ø160 mm  
WITH REMOTE CONTROL AND RELATIVE HUMIDITY, TEMPERATURE AND LIGHT SENSOR

**VORT HRW 30 MONO EVO**  
CODE 12434 Ø100 mm  
WITH ON-BOARD CONTROLS  
**VORT HRW 30 MONO EVO HCS**  
CODE 12436 Ø100 mm  
WITH REMOTE CONTROL AND RELATIVE HUMIDITY, TEMPERATURE AND LIGHT SENSOR





## RANGE EXPANSION

### Decentralised heat recovery units WITH Wi-Fi MODULE ABLE TO ESTABLISH MUTUAL COMMUNICATION BETWEEN PRODUCTS THROUGH A LOCAL MESH NETWORK

The Wi-Fi module is able to establish a mutual communication between VORT HRW MONO Wi-Fi, without having to install a router and stipulate a contract with an Internet service provider, but through a local MESH network, without the need for a wired connection between the products.



VORT HRW 40 MONO EVO Wi-Fi  
CODE 12442 Ø160 mm  
WITH ON-BOARD CONTROLS  
VORT HRW 40 MONO EVO HCS Wi-Fi  
CODE 12444 Ø160 mm  
WITH REMOTE CONTROL AND RELATIVE HUMIDITY, TEMPERATURE AND LIGHT SENSOR

VORT HRW 30 MONO EVO Wi-Fi  
CODE 12441 Ø100 mm  
WITH ON-BOARD CONTROLS  
VORT HRW 30 MONO EVO HCS Wi-Fi  
CODE 12443 Ø100 mm  
WITH REMOTE CONTROL AND RELATIVE HUMIDITY, TEMPERATURE AND LIGHT SENSOR

- ① Bedroom
- ② Bathroom
- ③ Living room/kitchen
- ④ Office



**VORT MONO RANGE**  
DECENTRALISED HEAT RECOVERY UNITS

**PERFORMANCE AND ABSORPTION**

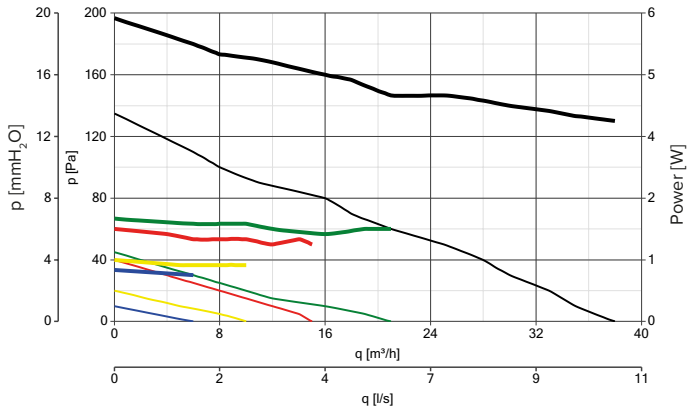

PRODUCT	CODE	Nom. Ø (mm)	(m <sup>3</sup> /h)	(W)	(PA)	Lp [dB (A)] 3m
VORT HRW 30 MONO EVO	12434	100	38	4	130	49.2
VORT HRW 30 MONO EVO HCS	12436	100	38	4	130	49.2

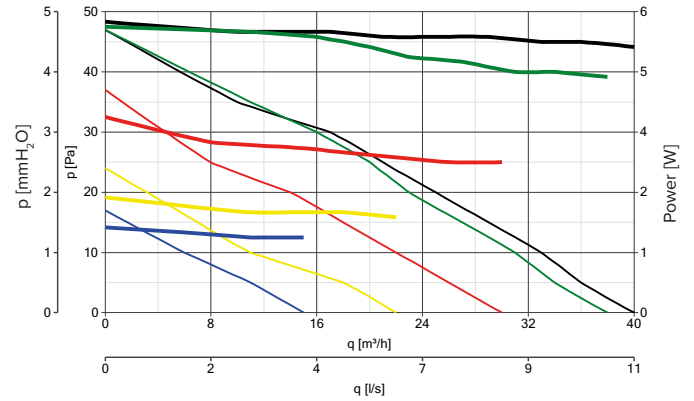

PRODUCT	CODE	Nom. Ø (mm)	(m <sup>3</sup> /h)	(W)	(PA)	Lp [dB (A)] 3m
VORT HRW 40 MONO EVO	12435	160	40	5	47	31.8
VORT HRW 40 MONO EVO HCS	12437	160	40	5	47	31.8

18

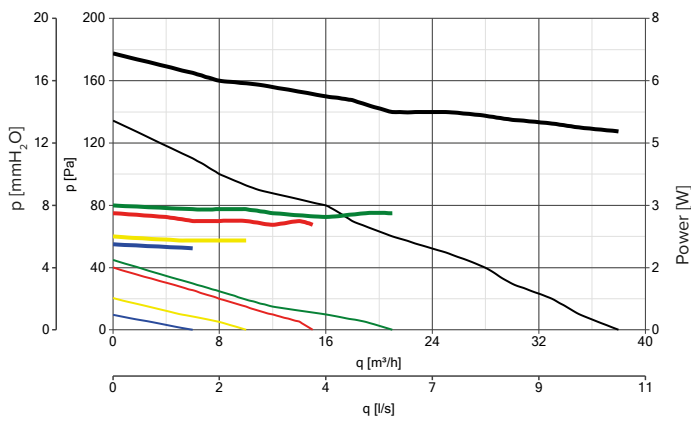

PRODUCT	CODE	Nom. Ø (mm)	(m <sup>3</sup> /h)	(W)	(PA)	Lp [dB (A)] 3m
VORT HRW 30 MONO EVO Wi-Fi 📶	12441	100	38	4	130	49.2
VORT HRW 30 MONO EVO HCS Wi-Fi 📶	12443	100	38	4	130	49.2

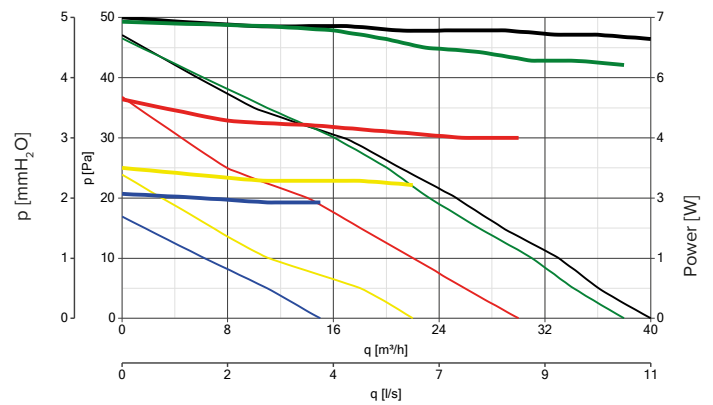

PRODUCT	CODE	Nom. Ø (mm)	(m <sup>3</sup> /h)	(W)	(PA)	Lp [dB (A)] 3m
VORT HRW 40 MONO EVO Wi-Fi 📶	12442	100	38	4	130	49.2
VORT HRW 40 MONO EVO HCS Wi-Fi 📶	12444	100	38	4	130	49.2

**KEY:**

**NIGHT MODE**

— Pressure  
— Power

**HIGH PERFORMANCE MODE**

— Pressure  
— Power

**PERFORMANCE MODE**

— Pressure  
— Power

**QUIET MODE**



— Pressure  
— Power

**BOOST MODE**

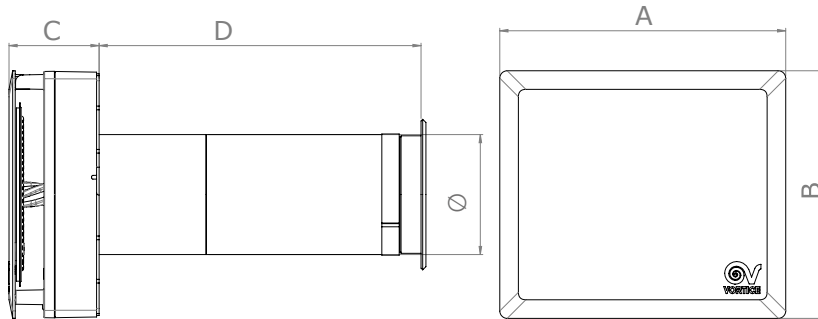

— Pressure  
— Power



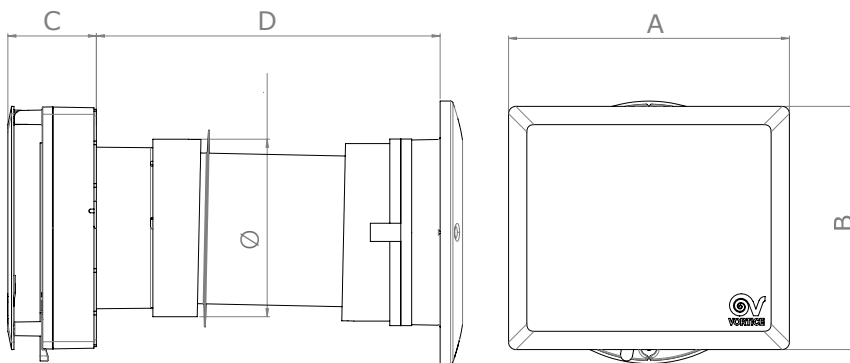

## DIMENSIONS



12434 VORT HRW 30 MONO EVO - 12436 VORT HRW 30 MONO EVO HCS  
 12441 VORT HRW 30 MONO EVO Wi-Fi  - 12443 VORT HRW 30 MONO EVO HCS Wi-Fi 



12435 VORT HRW 40 MONO EVO - 12437 VORT HRW 40 MONO EVO HCS  
 12442 VORT HRW 40 MONO EVO Wi-Fi  - 12444 VORT HRW 40 MONO EVO HCS Wi-Fi 

PRODUCTS	A	B	C	D	Ø
VORT HRW 30 MONO EVO	231	200	73	260	97
VORT HRW 30 MONO EVO HCS	231	200	73	260	97
VORT HRW 40 MONO EVO	231	200	73	283	146
VORT HRW 40 MONO EVO HCS	231	200	73	283	146
VORT HRW 30 MONO EVO Wi-Fi 	231	200	73	260	97
VORT HRW 30 MONO EVO HCS Wi-Fi 	231	200	73	260	97
VORT HRW 40 MONO EVO Wi-Fi 	231	200	73	283	146
VORT HRW 40 MONO EVO HCS Wi-Fi 	231	200	73	283	146

Dimensions in mm

**VORT MONO RANGE**  
DECENTRALISED HEAT RECOVERY UNITS

**ENERGY DATA - VORT HRW 30 MONO EVO/HCS**

	UNIT OF MEASURE- MENT	VORT HRW 30 MONO EVO CODE 12434	VORT HRW 30 MONO EVO HCS CODE 12436
MANUFACTURER'S NAME OR TRADE NAME	-	VORTICE	VORTICE
CLASS OF SPECIFIC ENERGY CONSUMPTION FOR TEMPERATE CLIMATE	-	A	A+
SPECIFIC ENERGY CONSUMPTION SEC (TEMPERATE CLIMATE)		- 41.2	-44.4
SPECIFIC ENERGY CONSUMPTION SEC (COLD CLIMATE)	kWh/m <sup>2</sup> year	- 85.4	- 89.5
SPECIFIC ENERGY CONSUMPTION SEC (WARM CLIMATE)		- 17.0	-19.3
DECLARED TYPE OF THE VENTILATION UNIT	-	UVR-U**	UVR-U**
DRIVE TYPE	-	VM***	VM***
HRS HEAT EXCHANGER TYPE	-	recovery	recovery
THERMAL EFFICIENCY OF HEAT RECOVERY AT THE HRS REFERENCE FLOW RATE	%	89.0	89.0
MAXIMUM FLOW RATE	m <sup>3</sup> /h	35	35
TOTAL ELECTRIC POWER ABSORBED BY THE FAN AT MAXIMUM FLOW RATE	W	4	4
NOISE LEVEL	LWA [dB(A)]	53.1	53.1
REFERENCE FLOW RATE	m <sup>3</sup> /s	0.0097	0.0097
REFERENCE PRESSURE DIFFERENCE	Pa	10	10
SPI****	W/(m <sup>3</sup> /h)	0.11429	0.11429
CTRL CONTROL FACTOR	-	1	0.65
CONTROL TYPE	-	manual	local premise
MAXIMUM PERCENTAGE OF INTERNAL LEAKAGE	%	NA*	NA*
MAXIMUM PERCENTAGE OF EXTERNAL LEAKAGE	%	NA*	NA*
MIXING RATE	-	NA*	NA*
VISUAL FILTER SIGNAL POSITION AND DESCRIPTION	-	see instruction booklet	see instruction booklet
AIR FLOW SENSITIVITY TO PRESSURE VARIATIONS AT ± 20 PA	-	0.48	0.48
INDOOR/OUTDOOR AIR TIGHTNESS	m <sup>3</sup> /h	0.0	0.0
AEC ANNUAL ELECTRICITY CONSUMPTION	kWh of electrici- ty/year	157	83
TEMPERATE AHS ANNUAL HEATING SAVING		4515	4650
COLD AHS ANNUAL HEATING SAVING	kWh of primary energy/year	8901	9141
WARM AHS ANNUAL HEATING SAVING		2057	2113

\* NA: Not applicable. \*\* UVR-U: Residential Ventilation Unit - Unidirectional. \*\*\* VM: Multiple speeds. VSD: Variable Speed Drive.

\*\*\*\* SPI: Specific power input.



## ENERGY DATA - VORT HRW 40 MONO EVO/HCS

	UNIT OF MEASUREMENT	VORT HRW 40 MONO EVO CODE 12435	VORT HRW 40 MONO EVO HCS CODE 12437
MANUFACTURER'S NAME OR TRADE NAME	-	VORTICE	VORTICE
CLASS OF SPECIFIC ENERGY CONSUMPTION FOR TEMPERATE CLIMATE	-	A	A+
SPECIFIC ENERGY CONSUMPTION SEC (TEMPERATE CLIMATE)		- 39.7	-43.7
SPECIFIC ENERGY CONSUMPTION SEC (COLD CLIMATE)	kWh/m <sup>2</sup> year	- 84.1	-88.8
SPECIFIC ENERGY CONSUMPTION SEC (WARM CLIMATE)		- 15.7	-18.6
DECLARED TYPE OF THE VENTILATION UNIT	-	UVR-U***	UVR-U***
DRIVE TYPE	-	VM	VM
HRS HEAT EXCHANGER TYPE	-	recovery	recovery
THERMAL EFFICIENCY OF HEAT RECOVERY AT THE HRS REFERENCE FLOW RATE	%	89	89
MAXIMUM FLOW RATE	m <sup>3</sup> /h	32.6	32.6
TOTAL ELECTRIC POWER ABSORBED BY THE FAN AT MAXIMUM FLOW RATE	W	5.4	5.4
NOISE LEVEL	LWA [dB(A)]	48.1	48.1
REFERENCE FLOW RATE	m <sup>3</sup> /s	0.0085	0.0085
REFERENCE PRESSURE DIFFERENCE	Pa	10	10
SPI****	W/(m <sup>3</sup> /h)	0.15686	0.15686
CTRL CONTROL FACTOR	-	1	0.65
CONTROL TYPE	-	manual	local premise
MAXIMUM PERCENTAGE OF INTERNAL LEAKAGE	%	NA*	NA*
MAXIMUM PERCENTAGE OF EXTERNAL LEAKAGE	%	NA*	NA*
MIXING RATE	-	NA*	NA*
VISUAL FILTER SIGNAL POSITION AND DESCRIPTION	-	see instruction booklet	see instruction booklet
AIR FLOW SENSITIVITY TO PRESSURE VARIATIONS AT ± 20 PA	-	0.48	0.48
INDOOR/OUTDOOR AIR TIGHTNESS	m <sup>3</sup> /h	0.0	0.0
AEC ANNUAL ELECTRICITY CONSUMPTION	kWh of electricity/year	216	113
TEMPERATE AHS ANNUAL HEATING SAVING		4515	4650
COLD AHS ANNUAL HEATING SAVING	kWh of primary energy/year	8901	9141
WARM AHS ANNUAL HEATING SAVING		2057	2113

\* NA: Not applicable. \*\* UVR-U: Residential Ventilation Unit - Unidirectional. \*\*\* VM: Multiple speeds. VSD: Variable Speed Drive.

\*\*\*\* SPI: Specific power input.

**VORT MONO RANGE**  
DECENTRALISED HEAT RECOVERY UNITS

**ENERGY DATA - VORT HRW 30 MONO EVO/HCS**





	UNIT OF MEASURE- MENT	VORT HRW 30 MONO EVO WI-FI CODE 12441	VORT HRW 30 MONO EVO HCS WI-FI CODE 12443
MANUFACTURER'S NAME OR TRADE NAME	-	VORTICE	VORTICE
CLASS OF SPECIFIC ENERGY CONSUMPTION FOR TEMPERATE CLIMATE	-	A	A+
SPECIFIC ENERGY CONSUMPTION SEC (TEMPERATE CLIMATE)	kWh/m <sup>2</sup> year	- 84.4	- 43.8
SPECIFIC ENERGY CONSUMPTION SEC (COLD CLIMATE)		- 40.0	- 89.0
SPECIFIC ENERGY CONSUMPTION SEC (WARM CLIMATE)		- 15.9	-18.7
DECLARED TYPE OF THE VENTILATION UNIT	-	UVR-U**	UVR-U**
DRIVE TYPE	-	VM***	VM***
HRS HEAT EXCHANGER TYPE	-	recovery	recovery
THERMAL EFFICIENCY OF HEAT RECOVERY AT THE HRS REFERENCE FLOW RATE	%	89.0	89.0
MAXIMUM FLOW RATE	m <sup>3</sup> /h	35	35
TOTAL ELECTRIC POWER ABSORBED BY THE FAN AT MAXIMUM FLOW RATE	W	5.2	5.2
NOISE LEVEL	LWA [dB(A)]	53.1	53.1
REFERENCE FLOW RATE	m <sup>3</sup> /s	0.0097	0.0097
REFERENCE PRESSURE DIFFERENCE	Pa	10	10
SPI****	W/(m <sup>3</sup> /h)	0.14857	0.14857
CTRL CONTROL FACTOR	-	1	0.65
CONTROL TYPE	-	manual	local premise
MAXIMUM PERCENTAGE OF INTERNAL LEAKAGE	%	NA*	NA*
MAXIMUM PERCENTAGE OF EXTERNAL LEAKAGE	%	NA*	NA*
MIXING RATE	-	NA*	NA*
VISUAL FILTER SIGNAL POSITION AND DESCRIPTION	-	see instruction booklet	see instruction booklet
AIR FLOW SENSITIVITY TO PRESSURE VARIATIONS AT ± 20 PA	-	0.48	0.48
INDOOR/OUTDOOR AIR TIGHTNESS	m <sup>3</sup> /h	0.0	0.0
AEC ANNUAL ELECTRICITY CONSUMPTION	kWh of electricity/year	205	107
TEMPERATE AHS ANNUAL HEATING SAVING	kWh of primary energy/year	4515	4650
COLD AHS ANNUAL HEATING SAVING		8901	9141
WARM AHS ANNUAL HEATING SAVING		2057	2113

\* NA: Not applicable. \*\* UVR-U: Residential Ventilation Unit - Unidirectional. \*\*\* VM: Multiple speeds. VSD: Variable Speed Drive.

\*\*\*\* SPI: Specific power input.

## ENERGY DATA - VORT HRW 40 MONO EVO/HCS

	UNIT OF MEASUREMENT	VORT HRW 40 MONO EVO Wi-Fi  CODE 12442	VORT HRW 40 MONO EVO HCS Wi-Fi  CODE 12444
MANUFACTURER'S NAME OR TRADE NAME	-	VORTICE	VORTICE
CLASS OF SPECIFIC ENERGY CONSUMPTION FOR TEMPERATE CLIMATE	-	A	A+
SPECIFIC ENERGY CONSUMPTION SEC (TEMPERATE CLIMATE)		- 38.4	-43.0
SPECIFIC ENERGY CONSUMPTION SEC (COLD CLIMATE)	kWh/m <sup>2</sup> year	- 82.9	-88.2
SPECIFIC ENERGY CONSUMPTION SEC (WARM CLIMATE)		- 14.4	-17.9
DECLARED TYPE OF THE VENTILATION UNIT	-	UVR-U**	UVR-U**
DRIVE TYPE	-	VM	VM
HRS HEAT EXCHANGER TYPE	-	recovery	recovery
THERMAL EFFICIENCY OF HEAT RECOVERY AT THE HRS REFERENCE FLOW RATE	%	89	89
MAXIMUM FLOW RATE	m <sup>3</sup> /h	32.6	32.6
TOTAL ELECTRIC POWER ABSORBED BY THE FAN AT MAXIMUM FLOW RATE	W	6.6	6.6
NOISE LEVEL	LWA [dB(A)]	48.1	48.1
REFERENCE FLOW RATE	m <sup>3</sup> /s	0.0085	0.0085
REFERENCE PRESSURE DIFFERENCE	Pa	10	10
SPI****	W/(m <sup>3</sup> /h)	0.19608	0.19608
CTRL CONTROL FACTOR	-	1	0.65
CONTROL TYPE	-	manual	local premise
MAXIMUM PERCENTAGE OF INTERNAL LEAKAGE	%	NA*	NA*
MAXIMUM PERCENTAGE OF EXTERNAL LEAKAGE	%	NA*	NA*
MIXING RATE	-	NA*	NA*
VISUAL FILTER SIGNAL POSITION AND DESCRIPTION	-	see instruction booklet	see instruction booklet
AIR FLOW SENSITIVITY TO PRESSURE VARIATIONS AT ± 20 PA	-	0.48	0.48
INDOOR/OUTDOOR AIR TIGHTNESS	m <sup>3</sup> /h	0.0	0.0
AEC ANNUAL ELECTRICITY CONSUMPTION	kWh of electricity/year	270	142
TEMPERATE AHS ANNUAL HEATING SAVING		4515	4650
COLD AHS ANNUAL HEATING SAVING	kWh of primary energy/year	8901	9141
WARM AHS ANNUAL HEATING SAVING		2057	2113

\* NA: Not applicable. \*\* UVR-U: Residential Ventilation Unit - Unidirectional. \*\*\* VM: Multiple speeds. VSD: Variable Speed Drive.

\*\*\*\* SPI: Specific power input.

**VORT MONO RANGE**  
DECENTRALISED HEAT RECOVERY UNITS





## TECHNICAL FEATURES

- **8 models**, with on-board controls, remote control, and relative humidity, temperature and light sensor.
- **Pressed wall casing** made of aesthetic plastic resin, resistant to impacts and ageing induced by light; it integrates controls for switching the appliance on and off, and regulating the operating modes and the treated flow. In the HCS models, it also integrates a relative humidity and light sensor for the automatic operation of the product.
- The **fans** used in the products of the VORT MONO RANGE comply with the European ERP Directive no. 2009/125.
- **EC motor fans**, to ensure very low consumption, powered by low voltage and with shafts mounted on ball bearings. Featuring 5 operating speeds, for the best compromise between air flow rate, consumption, and noise emission, they are designed to work in a clockwise and anti-clockwise direction, thus allowing the product to operate in the Intake, Ventilation and Ventilation with heat recovery modes.
- **High-efficiency (90%) storage heat exchangers**, made of ceramic material of the hexagonal cell type to maximise the heat exchange surface. In winter operation (in summer the logic is reversed), thanks to the periodic inversion of the rotation direction of the motor fan, the exchange pack is cyclically heated by the hot air extracted and subsequently transfers most of this heat to the incoming cold renewal air.
- **Grilles** External molded rubber grilles, which can be mounted from the inside through the hole in the target wall, to simplify the installation of the product. The grilles include an easily removable anti-insect net to simplify cleaning operations.
- **Washable G3 filters**, easily accessible for maintenance and cleaning. Pre-filters, housed on the internal side.

### 3 operating modes:

- **Ventilation with heat recovery:** the fan periodically reverses the direction of rotation to allow the transfer of the flow at a lower temperature than the heat previously accumulated in the exchanger.
- **Ventilation in extraction mode:** the fan always operates in extraction mode.
- **Ventilation in delivery mode:** the fan always operates in delivery mode.
- **Electrical insulation class:** II (earthing not required).

## TECHNICAL DATA

PRODUCTS	CODE	V~50-60 HZ	W max	MAX FLOW RATE			MAX PRESSURE			LP dB (A) 3m min/max	°C MAX	KG
				A max	m³/h min/max	l/s min/max	mmH₂O min / max	Pa min/max				
VORT HRW 30 MONO EVO	12434	220-240	4	0.04	6 38	1.7 10.5	1 13.7	10 130	19.1 49.2	30	3.1	
VORT HRW 30 MONO EVO HCS	12436	220-240	4	0.04	6 38	1.7 10.5	1 13.7	10 130	19.1 49.2	30	3.1	
VORT HRW 40 MONO EVO	12435	220-240	5	0.05	15 40	4.2 11.1	1.7 4.8	17 47	19 31.8	30	3.3	
VORT HRW 40 MONO EVO HCS	12437	220-240	5	0.05	14 40	4.2 11.1	1.7 4.8	17 47	19 31.8	30	3.3	
VORT HRW 30 MONO EVO Wi-Fi 	12441	220-240	4	0.04	6 38	1.7 10.5	1 13.7	10 130	19.1 49.2	30	3.1	
VORT HRW 30 MONO EVO HCS Wi-Fi 	12443	220-240	4	0.04	6 38	1.7 10.5	1 13.7	10 130	19.1 49.2	30	3.1	
VORT HRW 40 MONO EVO Wi-Fi 	12442	220-240	5	0.05	15 40	4.2 11.1	1.7 4.8	17 47	19 31.8	30	3.3	
VORT HRW 40 MONO EVO HCS Wi-Fi 	12444	220-240	5	0.05	15 40	4.2 11.1	1.7 4.8	17 47	19 31.8	30	3.3	



## IR remote control (only for HCS models -)

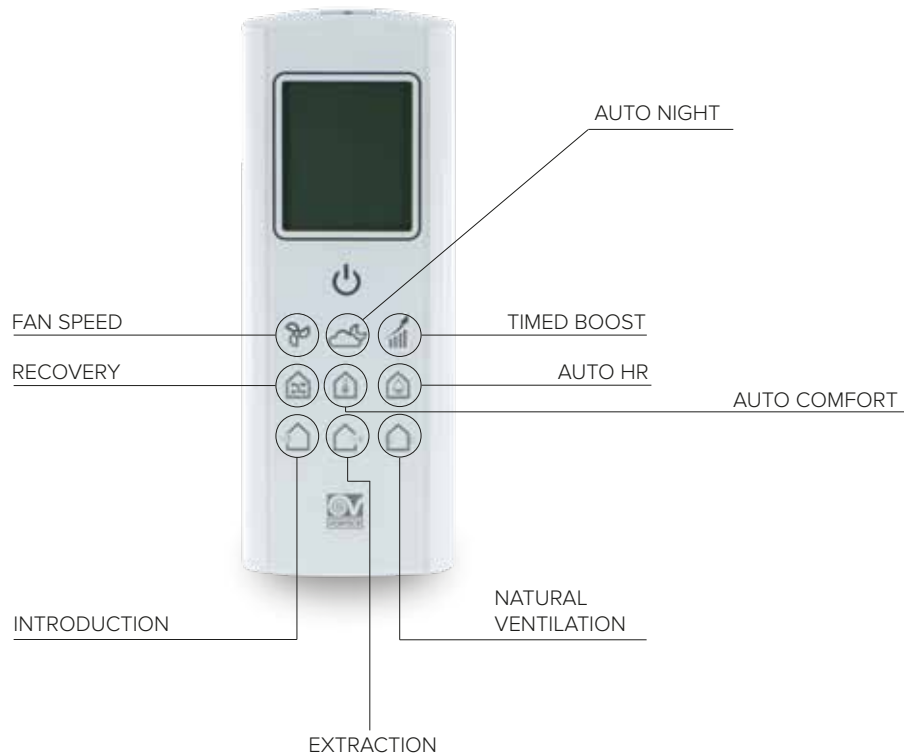

### HCS models are supplied with remote control with LCD display.

By default the recovery function and the auto-comfort, auto HR% and auto night modes are active. The humidity threshold is set at the maximum value (90%) and the fan is set at maximum speed to obtain the maximum flow rate (5 fans displayed). The remote control transmits its default status to the product and updates the status on the appliance accordingly. If the status of the machine does not synchronise with the status of the remote control, point the remote control at the appliance and press a button on the remote control to activate the synchronisation.

#### **AUTO NIGHT**

The ambient light sensor detects the presence or absence of light in the room.

Therefore, if it is night and no daylight is detected, the product will run at minimum speed and will not be allowed to go above minimum speed.

When the presence of daylight is detected again, the product returns to operate at the previously set speed, and the switch to higher boost speeds is allowed via remote input or HR% sensor.

#### **AUTO HR%**

In case of humidity above the alarm threshold (60%, 75%, or 90% - the default value is 75%), the extraction mode at maximum speed is automatically selected.

#### **AUTO COMFORT**

In heat recovery mode, the period that determines the inversion of rotation of the fans is set based on the temperature of the air introduced into the room: if it is too cold, the cycle time is reduced.

## MAIN COMPONENTS

### VORT HRW 30 MONO EVO - VORT HRW 30 MONO EVO HCS

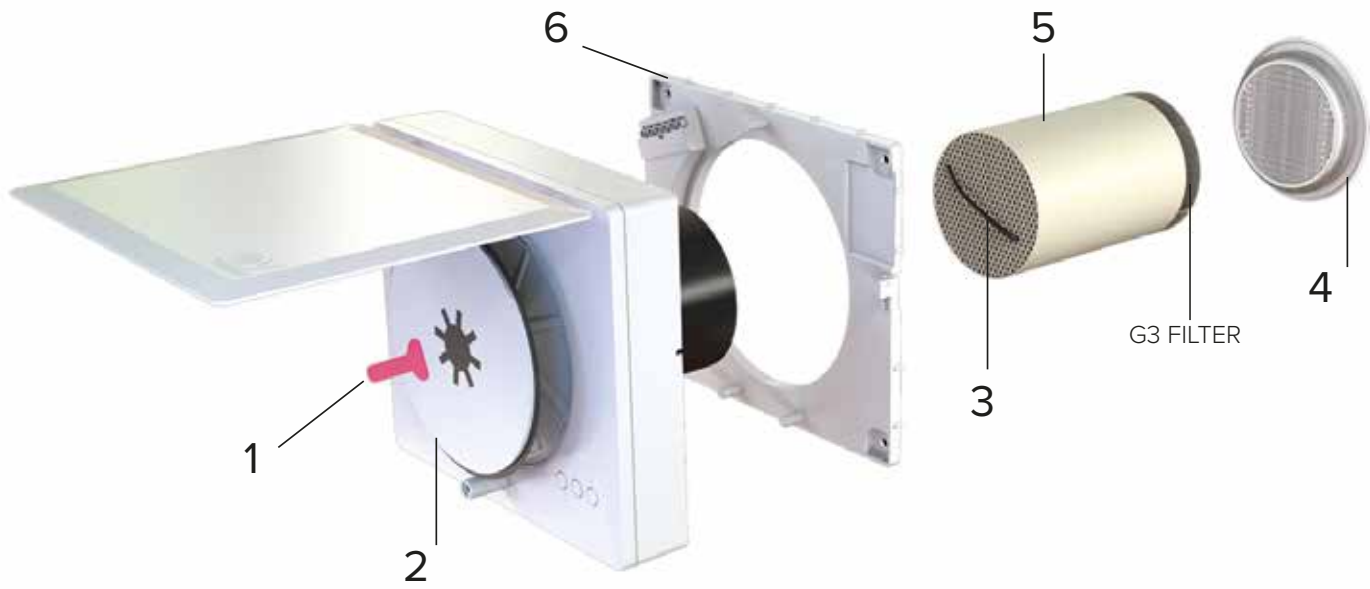

1. MECHANICAL CLOSING DISK LEVER, TO AVOID THE PASSAGE OF AIR WHEN THE MACHINE IS NOT WORKING.
2. CO-MOLDED FRONT DISK, TO HELP ATTENUATE THE SOUND WAVE CREATED BY THE VENTILATING SYSTEM AND BY THE AIR FLOW DURING THE DELIVERY INTO THE ENVIRONMENT. ITS SURFACE WITH SPHERICAL CAPS TENDS TO REFLECT THE NOISE IN DIFFERENT DIRECTIONS, ATTENUATING ITS EFFECT.
3. EXCHANGE PACK EXTRACTION CABLE
4. EXTERNAL GRILLE, MADE OF PLASTIC MATERIAL, EQUIPPED WITH ANTI-INSECT NET
5. EXCHANGE PACK OF THE ACCUMULATION TYPE, MADE OF CERAMIC MATERIAL WITH EXTERNAL FILTER ASSEMBLED.
6. FLANGE FOR WALL INSTALLATION WITH PRE-INSTALLED TERMINAL BLOCK.THE PROTECTION CLASS OF THE TERMINAL BLOCK ALLOWS AN INEXPERIENCED USER TO REMOVE THE FAN BODY AND TO PROCEED WITH THE REMOVAL AND CLEANING OF THE EXCHANGE PACK, OF THE G3 FILTER, AND TO RESET THE SYSTEM.

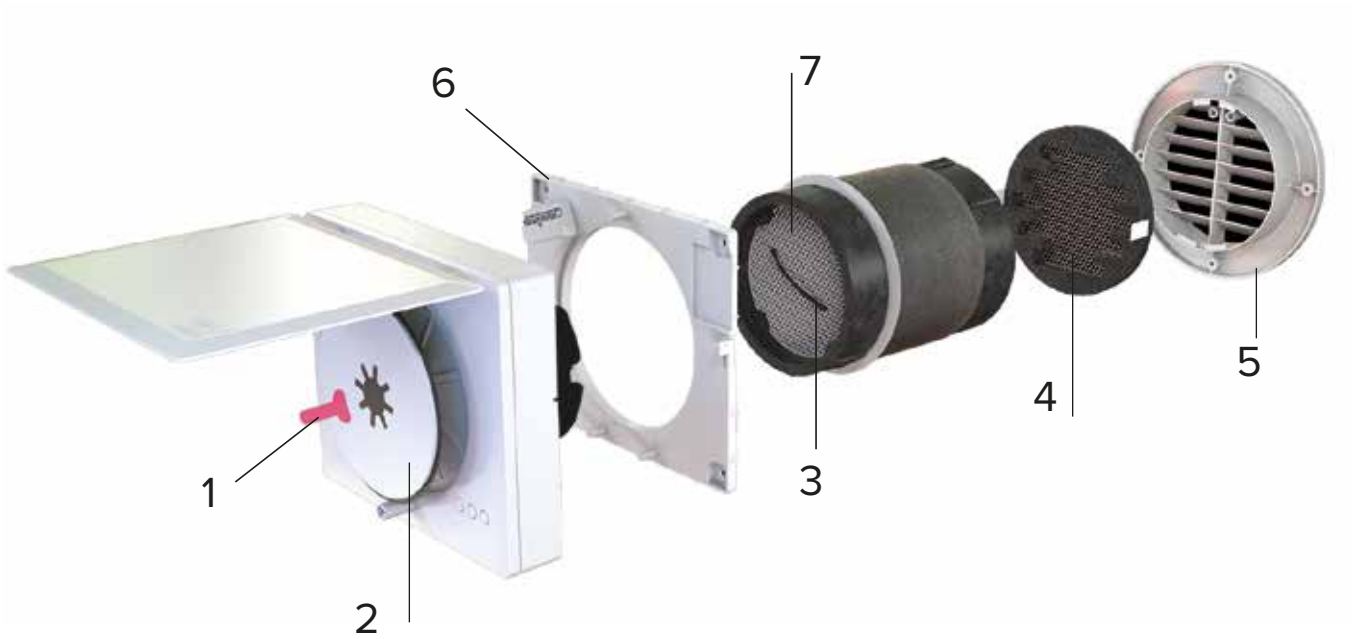

## MAIN COMPONENTS

### VORT HRW 40 MONO EVO - VORT HRW 40 MONO EVO HCS



- 1.** MECHANICAL CLOSING DISK LEVER, TO AVOID THE PASSAGE OF AIR WHEN THE MACHINE IS NOT WORKING.
- 2.** CO-MOLDED FRONT DISK, TO HELP ATTENUATE THE SOUND WAVE CREATED BY THE VENTILATING SYSTEM AND BY THE AIR FLOW DURING THE DELIVERY INTO THE ENVIRONMENT. ITS SURFACE WITH SPHERICAL CAPS TENDS TO REFLECT THE NOISE IN DIFFERENT DIRECTIONS, ATTENUATING ITS EFFECT.
- 3.** EXCHANGE PACK EXTRACTION CABLE
- 4.** ANTI-INSECT GRILLE, REMOVABLE AND WASHABLE BY THE USER OPERATING FROM THE INSIDE OF THE HOUSE
- 5.** EXTERNAL GRILLE MADE OF TPV RUBBER.
- 6.** FLANGE FOR WALL INSTALLATION WITH PRE-INSTALLED TERMINAL BLOCK.THE PROTECTION CLASS OF THE TERMINAL BLOCK ALLOWS AN INEXPERIENCED USER TO REMOVE THE FAN BODY AND TO PROCEED WITH THE REMOVAL AND CLEANING OF THE EXCHANGE PACK, OF THE G3 FILTER, AND TO RESET THE SYSTEM.
- 7.** THE POLYPROPYLENE RINGS FEATURE SOME PROTUBERANCES FOR THE ALIGNMENT OF THE FRONT SURFACE OF THE EXCHANGER WITH THE OUTLET/INLET OF THE FAN AND THE CORRECT INCLINATION OF THE EXCHANGER WITH RESPECT TO THE CONTAINMENT PIPE INSERTED IN THE WALL

## REGULATORS













MODELS	DESCRIPTION	DIMENSIONS	CODE	VORT HRW 40 MONO EVO code12435	VORT HRW 40 MONO EVO HCS code12437	VORT HRW 40 MONO EVO Wi-Fi code12442	VORT HRW 40 MONO EVO HCS Wi-Fi code12444
	<b>C TEMP</b> Control sensor for air temperature in the environment	144x54x55.8	12992	✓	✓	✓	✓
	<b>C HCS</b> Control sensor for relative humidity (RH) in the air	144x54x55.8	12994	✓	✓	✓	✓

## ACCESSORIES

MODELS	DESCRIPTION	CODE	VORT HRW 30 MONO EVO code 12434	VORT HRW 30 MONO EVO HCS code 12436	VORT HRW 40 MONO EVO code 12435	VORT HRW 40 MONO EVO HCS code 12437
	<b>MWS Ø 100</b> Windproof metal panel for outdoor in stainless steel sheet	21883	✓	✓		
	<b>WA Ø 100</b> 90° round/square adapter for extraction and discharge through a window frame. Circular connection diameter 100 mm	21884	✓	✓		
	<b>KIT FTR</b> Filter kit	21891	✓	✓		
	<b>PVC PIPE Ø 100</b>	21879	✓	✓		
	<b>PVC PIPE Ø 160</b>	22599			✓	✓
	<b>KIT FTR</b> Filter kit	22466			✓	✓
	<b>MWS</b> Windproof metal panel for outdoor in stainless steel sheet Circular connection diameter for 160 mm	21148			✓	✓
	<b>RGR</b> External rubber grille	21190			✓	✓
	<b>WSG-INOX</b> Rectangular stainless steel grille for the WA kit	21192			✓	✓
	<b>WSG-W</b> Powder coated stainless steel rectangular grid for the WA kit	21193			✓	✓
	<b>FTR M5</b> Filters	21926			✓	✓
	<b>WA</b> 90° round/square adapter for extraction and discharge through a window frame. Circular connection diameter for 160 mm	21191			✓	✓



## ACCESSORIES

MODELS	DESCRIPTION	CODE	VORT HRW 30 MONO EVO Wi-Fi code 12441 :))	VORT HRW 30 MONO EVO HCS Wi-Fi :)) code 12443	VORT HRW 40 MONO EVO Wi-Fi code 12442	VORT HRW 30 MONO EVO HCS Wi-Fi :)) code 12444
	<b>MWS Ø 100</b> Windproof metal panel for outdoor in stainless steel sheet	<b>21883</b>	✓	✓		
	<b>WA Ø 100</b> 90° round/square adapter for extraction and discharge through a window frame. Circular connection diameter 100 mm	<b>21884</b>	✓	✓		
	<b>KIT FTR</b> Filter kit	<b>21891</b>	✓	✓		
	<b>PVC PIPE Ø 100</b>	<b>21879</b>	✓	✓		
	<b>PVC PIPE Ø 160</b>	<b>22599</b>			✓	✓
	<b>KIT FTR</b> Filter kit	<b>22466</b>			✓	✓
	<b>MWS</b> Windproof metal panel for outdoor in stainless steel sheet Circular connection diameter for 160 mm	<b>21148</b>			✓	✓
	<b>RGR</b> External rubber grille	<b>21190</b>			✓	✓
	<b>WSG-INOX</b> Rectangular stainless steel grille for the WA kit	<b>21192</b>			✓	✓
	<b>WSG-W</b> Powder coated stainless steel rect- angular grid for the WA kit	<b>21193</b>			✓	✓
	<b>FTR M5</b> Filters	<b>21926</b>			✓	✓
	<b>WA</b> 90° round/square adapter for extraction and discharge through a window frame. Circular connection diameter for 160 mm	<b>21191</b>			✓	✓

# VORT HR NETIRANGE

WALL HEAT RECOVERY UNIT

**A**

**WALL AND FLOOR CENTRALISED**

**VENTILATION**

**UP TO 180 M<sup>2</sup>**

Centralised dual-flow ventilation unit with heat recovery for floor and wall installation, ideal for ventilation of homes as well as residential and commercial premises with a surface area of up to 180 m<sup>2</sup>.



- Internal structure in high-density (40 kg/m<sup>3</sup>) expanded polypropylene.
- Aesthetic front panel made of plastic resin, glossy white finish.
- Connection spigots to pipes with 125 mm nominal diameter, backward curved centrifugal fans directly coupled to EC motors.
- High-efficiency counterflow heat exchanger made of plastic material (PS).
- Automatic mechanical by-pass for free-cooling.
- ePM10 50% (M5) and Coarse 65% (G4) filters, located in correspondence with the inlet and outlet ducts respectively.
- Integrated control panel (Remote control panel with optional wired connection)
- Support bracket for wall installation integrated in the product
- Can be integrated into residential home automation systems (ModBus protocol) on RS485 SLAVE mode.

30

## PERFORMANCE AND ABSORPTION

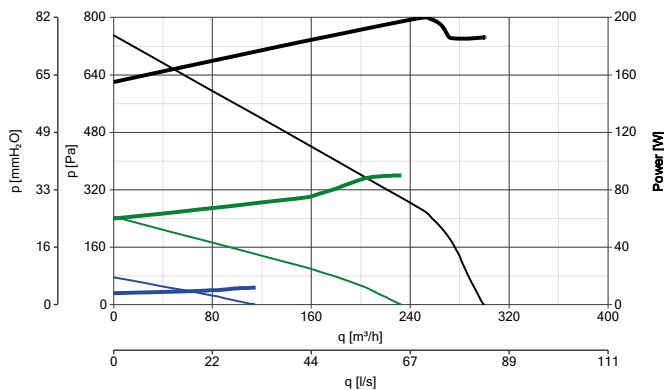

## TECHNICAL DATA

PRODUCT	CODE	Nom. Ø (mm)	(m <sup>3</sup> /h)	(W)	(PA)	Lp [dB (A)] 3m
VORT HR 300 NETI	10935	125	300	190	735	24

CONSUMPTION CURVES  
 — max  
 — avg  
 — min

PERFORMANCE CURVES  
 — max  
 — avg  
 — min

## DIMENSIONS

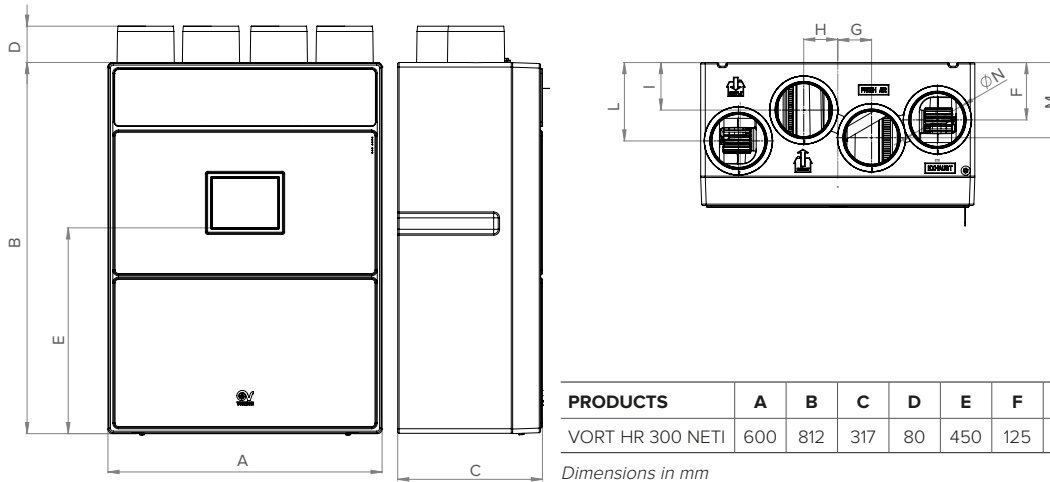

## ENERGY DATA

	UNIT OF MEASUREMENT	VORT HR 300 NETI
MANUFACTURER'S NAME OR TRADE NAME	-	VORTICE
CLASS OF SPECIFIC ENERGY CONSUMPTION FOR TEMPERATE CLIMATE	-	A
SPECIFIC ENERGY CONSUMPTION SEC (TEMPERATE CLIMATE)	kWh/m <sup>2</sup> year	- 35
SPECIFIC ENERGY CONSUMPTION SEC (COLD CLIMATE)		- 74
SPECIFIC ENERGY CONSUMPTION SEC (WARM CLIMATE)		- 11
DECLARED TYPE OF THE VENTILATION UNIT	-	UVR-B**
DRIVE TYPE	-	VSD***
HRS HEAT EXCHANGER TYPE	-	recovery
THERMAL EFFICIENCY OF HEAT RECOVERY AT THE HRS REFERENCE FLOW RATE	%	87.9
MAXIMUM FLOW RATE	m <sup>3</sup> /h	270
TOTAL ELECTRIC POWER ABSORBED BY THE FAN AT MAXIMUM FLOW RATE	w	190
NOISE LEVEL	LWA [dB(A)]	57.2
REFERENCE FLOW RATE	m <sup>3</sup> /s	0.0525
REFERENCE PRESSURE DIFFERENCE	Pa	56
SPI****	W/(m <sup>3</sup> /h)	0.4392
CTRL CONTROL FACTOR	-	0.85
CONTROL TYPE	-	centralised env.
MAXIMUM PERCENTAGE OF INTERNAL LEAKAGE	%	2.8
MAXIMUM PERCENTAGE OF EXTERNAL LEAKAGE	%	2.3
MIXING RATE	-	NA*
VISUAL FILTER SIGNAL POSITION AND DESCRIPTION	-	See instruction booklet
AIR FLOW SENSITIVITY TO PRESSURE VARIATIONS AT ± 20 PA	-	NA*
INDOOR/OUTDOOR AIR TIGHTNESS	m <sup>3</sup> /h	NA*
AEC ANNUAL ELECTRICITY CONSUMPTION	kWh of electricity/year	442
TEMPERATE AHS ANNUAL HEATING SAVING	kWh of primary energy/year	4573
COLD AHS ANNUAL HEATING SAVING		8946
WARM AHS ANNUAL HEATING SAVING		2068

\* NA: Not applicable. \*\* UVR-U: Residential Ventilation Unit - Unidirectional. \*\*\* VM: Multiple speeds. VSD: Variable Speed Drive.

\*\*\*\* SPI: Specific power input.

## TECHNICAL FEATURES

- **1 model.**
- Fire-resistant expanded polypropylene casing (DIN EN 13501). Brackets for wall installation included in the standard equipment.
- Aesthetic front panels made of white polycarbonate (alternative colours available on request), integrating the panels for direct access to the filters.
- Intake and delivery spigots compatible with the combination with pipes with 125 mm nominal diameter.
- Pair of motor fans driven by EC (brushless) motors of the external rotor type, with shafts mounted on ball bearings to ensure a virtually “maintenance free” operation, directly coupled to backward curved centrifugal impellers to guarantee high aerodynamic efficiency. 3 operating speeds, independently settable upon installation.
- High-efficiency counterflow heat exchanger made of plastic material (PS).
- Anti-frost protection with automatic activation, to prevent the formation of frost at the heat exchanger.
- Mechanical, automatic and 100% filtered by-pass, to guarantee the comfort of the occupants of the rooms in mid-seasons, or whenever the outside temperature does not require the action of the heat exchanger.
- Control unit with LCD display, for:
  - turning the product on and off;
  - initial configuration of the product;
  - manual setting of the operating mode;
  - automatic management of the product and monitoring of its correct operation;
  - system diagnostics;
  - constant monitoring of the filters condition and signalling the need for their maintenance/replacement;
  - updating the firmware release.
- Pair of M5 filters (F7 filter available as an option for the delivery duct), easily accessible for periodic maintenance interventions.
- Condensate collection tray with drain devices.
- Possibility of integration in home automation environments through the ModBus communication protocol.
- Possibility of interlocking with external environmental sensors (optional), for the automatic control of the operating mode.
- Degree of protection from dust and water: IPX2.
- Electrical insulation class: I (earthing required).

## TECHNICAL DATA



PRODUCTS	CODE	V~50/60 HZ	W max	A max	MAX FLOW RATE		MAX PRESSURE		°C* MAX	KG
					m <sup>3</sup> /h	l/s	mmH <sub>2</sub> O	Pa		
VORT HR 300 NETI	10935	220 - 240	190	1.33	300	83	75	735	40	15

\* Maximum temperature with continuous operation of the product.









## FILTERS

MODELS	DESCRIPTION	DIMENSIONS	CODE	VORT HR NETI code 10935
	<b>FILTER M5</b>	275X125X48	21410	✓
	<b>FILTER G4</b>	275X125X48	21411	✓
	<b>FILTER F7</b>	275X125X48	21201	✓
	<b>FILTER F8</b>	275X125X48	21202	✓

## REGULATORS

MODELS	DESCRIPTION	DIMENSIONS	CODE	VORT HR NETI code 10935	CB LCD R code 21194
	<b>CB LCD R</b> Remote control unit with wired LCD panel, For recessed installation.	116x83x65	21194	✓	
	<b>WALL HRW RC BOX</b>	-	22732	✓	✓
	<b>BUILT-IN BOX TYPE 503</b>	-	22461	✓	✓
	<b>CB LCD</b> Remote control	-	21381	✓	

## ACCESSORIES

MODELS	DESCRIPTION	CODE	VORT HR NETI code 10935
	<b>HEATER 750</b> Pre-heater to prevent the formation of frost in correspondence of the heat exchanger, also in particularly harsh climates. 750 W Heater	22735	✓

# VORT HR AVEL RANGE

WALL HEAT RECOVERY UNIT



**CENTRALISED WALL**

**VENTILATION**

**UP TO 240 M<sup>2</sup>**

Centralised dual-flow units with heat recovery for floor and wall installation, ideal for ventilation of houses as well as residential and commercial premises with a surface area of up to 240 m<sup>2</sup>, featuring high levels of thermal insulation.



- Internal and external structure in high-density (40 kg/m<sup>3</sup>) expanded polypropylene.
- Connection spigots to pipes with 150 mm nominal diameter, centrifugal fans with backward curved blades directly coupled to EC motors.
- High-efficiency counterflow heat exchanger made of plastic material (PS).
- Automatic mechanical by-pass for free-cooling.
- ePM10 50% (M5) and Coarse 30% (G3) filters, located in correspondence with the inlet and outlet ducts respectively.
- Automatic anti-frost function.
- Standard wired remote LCD control panel, can be housed in a 503 box.
- Bracket for wall installation supplied as an option.
- Floor or wall installation. Can be integrated into residential home automation systems (ModBus protocol) on RS485 SLAVE mode.

34

## PERFORMANCE AND ABSORPTION

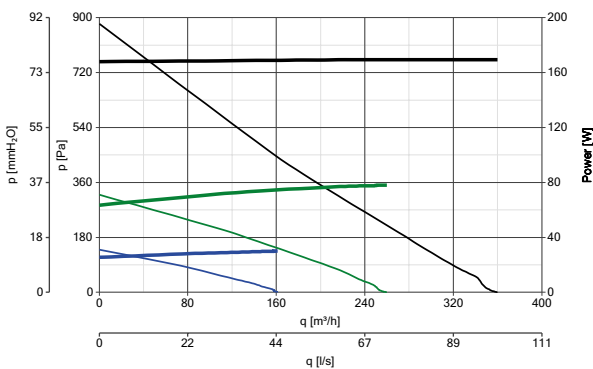

## TECHNICAL DATA

CODE	Nom. Ø (mm)	(m <sup>3</sup> /h)	(W)	(PA)	Lp [db(A)] 3m
12106	150	350	165	880	23.1

## DIMENSIONS

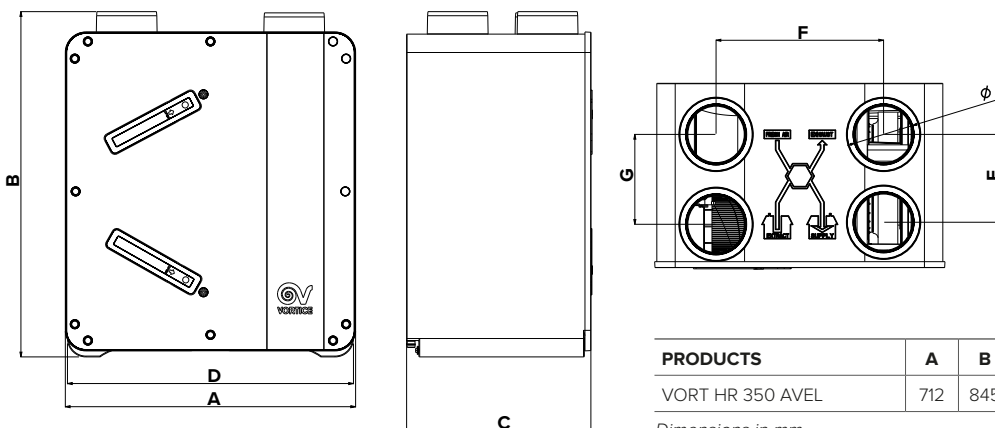

PRODUCTS	A	B	C	D	E	F	G	Ø
VORT HR 350 AVEL	712	845	455	700	215	410	220	150

Dimensions in mm



## ENERGY DATA

	UNIT OF MEASUREMENT	VORT HR 350 AVEL
MANUFACTURER'S NAME OR TRADE NAME	-	VORTICE
CLASS OF SPECIFIC ENERGY CONSUMPTION FOR TEMPERATE CLIMATE	-	A
SPECIFIC ENERGY CONSUMPTION SEC (TEMPERATE CLIMATE)	kWh/m <sup>2</sup> year	-38.4
SPECIFIC ENERGY CONSUMPTION SEC (COLD CLIMATE)		-77.0
SPECIFIC ENERGY CONSUMPTION SEC (WARM CLIMATE)		-13.6
DECLARED TYPE OF THE VENTILATION UNIT	-	UVR-B**
DRIVE TYPE	-	VSD***
HRS HEAT EXCHANGER TYPE	-	recovery
THERMAL EFFICIENCY OF HEAT RECOVERY AT THE HRS REFERENCE FLOW RATE	%	88.9
MAXIMUM FLOW RATE	m <sup>3</sup> /h	315
TOTAL ELECTRIC POWER ABSORBED BY THE FAN AT MAXIMUM FLOW RATE	w	170.0
NOISE LEVEL	LWA [dB(A)]	57
REFERENCE FLOW RATE	m <sup>3</sup> /s	0.0613
REFERENCE PRESSURE DIFFERENCE	Pa	70
SPI****	W/(m <sup>3</sup> /h)	0.31746
CTRL CONTROL FACTOR	-	0.85
CONTROL TYPE	-	centralised env.
MAXIMUM PERCENTAGE OF INTERNAL LEAKAGE	%	3.4
MAXIMUM PERCENTAGE OF EXTERNAL LEAKAGE	%	3.3
MIXING RATE	-	NA*
VISUAL FILTER SIGNAL POSITION AND DESCRIPTION	-	see instruction booklet
AIR FLOW SENSITIVITY TO PRESSURE VARIATIONS AT ± 20 PA	-	NA*
INDOOR/OUTDOOR AIR TIGHTNESS	m <sup>3</sup> /h	NA*
AEC ANNUAL ELECTRICITY CONSUMPTION	kWh of electricity/ year	332
TEMPERATE AHS ANNUAL HEATING SAVING	kWh of primary energy/ year	4600
COLD AHS ANNUAL HEATING SAVING		8999
WARM AHS ANNUAL HEATING SAVING		2080

\* NA: Not applicable. \*\* UVR-U: Residential Ventilation Unit - Unidirectional. \*\*\* VM: Multiple speeds. VSD: Variable Speed Drive.

\*\*\*\* SPI: Specific power input.

**VORT HR AVEL RANGE**  
WALL HEAT RECOVERY UNIT

## TECHNICAL FEATURES

- Fire-resistant expanded polypropylene casings (DIN EN 13501). Front panel made of loaded plastic resin with panels for direct access to the filters.
- Spigots for **extraction and delivery** compatible with pipes with 150 mm nominal diameter.
- **Pair of motor fans driven by EC (brushless) motors** of the external rotor type, with shafts mounted on ball bearings to ensure a virtually “maintenance free” operation, directly coupled to centrifugal impellers with backward curved blades to guarantee high aeraulic efficiency. 2 operating speeds.
- **High-efficiency heat exchanger**, of the cross-flow type with counterflow, made of plastic resin (PS).
- **Automatic activation anti-frost protection**, to prevent the formation of frost at the heat exchanger.
- **Mechanical, automatic, and 100% filtered by-pass**, to guarantee the comfort of the occupants of the rooms in mid-seasons, or whenever the outside temperature does not require the action of the heat exchanger.
- **Pair of M5 filters** (F7 filter available as an option for the delivery pipe) and **pair of Class ePM1 70% filters**
- **Condensate collection tray** with drain devices.
- **Brackets for wall installation** included in the standard equipment.
- Possibility of **interlocking with external environmental sensors** (optional), for the automatic control of the operating mode.
- **Degree of protection from dust and water**: IPX2
- **Electrical insulation class**: I (earthing required).

36

## TECHNICAL DATA

PRODUCTS	CODE	V~50 HZ	W max	A max	MAX FLOW RATE		MAX PRESSURE		°C* MAX	KG
					m <sup>3</sup> /h	l/s	mmH <sub>2</sub> O	Pa		
VORT HR 350 AVEL	12106	230	165	1.4	350	100	90	880	40	23

\* Maximum temperature with continuous operation of the product.

## EFFICIENCY CURVES

EFFICIENCY IN ACCORDANCE WITH FLOW RATE

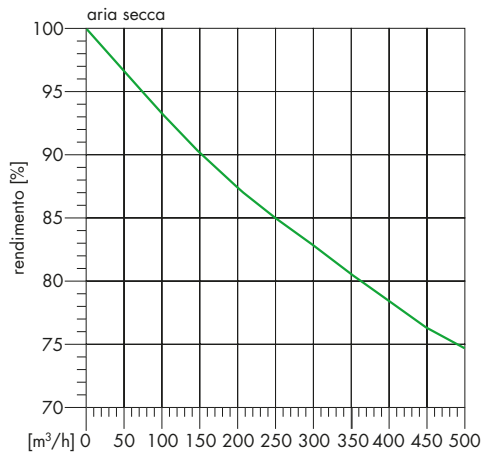

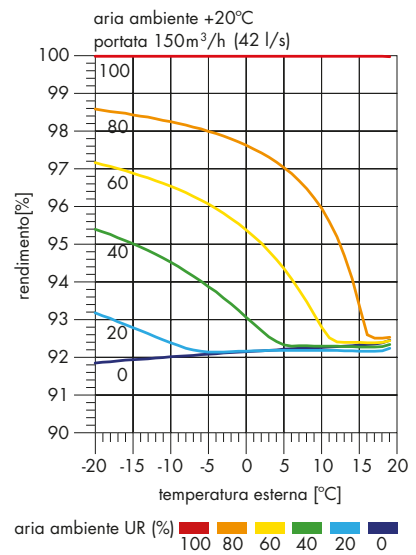

EFFICIENCY IN ACCORDANCE WITH CONDENSATION HEAT







**VORT HR AVEL RANGE**  
WALL HEAT RECOVERY UNIT



**FILTERS**

MODELS	DESCRIPTION	DIMENSIONS	CODE	VORT HR AVEL 350 code 12106
	<b>FILTER G3</b>	198x398x15	22661	✓
	<b>FILTER M5</b>	198X398X15	22662	✓
	<b>FILTER F7</b>	198X398X15	22664	✓

**REGULATORS**

MODELS	DESCRIPTION	DIMENSIONS	CODE	VORT HR AVEL 350 code 12106
	<b>C TEMP</b> Temperature detector	144x54x55.8	12992	✓
	<b>C SMOKE</b> Polluted air detector	144x54x55.8	12993	✓
	<b>C HCS</b> Humidity detector	144x54x55.8	12994	✓
	<b>C PIR</b> Presence detector	144x54x55.8	12998	✓

**ACCESSORIES**

MODELS	DESCRIPTION	CODE	VORT HR AVEL 350 code 12106
	<b>AVEL WALL FIXING KIT</b>	22663	✓
	<b>750-W HEATER</b> Pre-heater to prevent the formation of frost in correspondence of the heat exchanger, also in particularly rigid climates	22735	✓



## NOTES

---

---

---

---

---

---

---

---

---

---

---

---

---

---

---

---

---

---

---

---

---

---

---

---

---

---

---

---

---

---

---

# VORT HR AVEL RANGE

WALL HEAT RECOVERY UNIT



**CENTRALISED WALL**

**VENTILATION**

**UP TO 260 M<sup>2</sup>**

Centralised dual-flow units with heat recovery for wall installation, ideal for ventilation of homes as well as residential and commercial premises with a surface of up to 260 m<sup>2</sup>.



- High heat exchange efficiency
- Easy installation and maintenance: the front panel gives direct access to the main internal components. The position of the electrical contacts and electronics, placed on the upper side of the product, facilitates the connection to the electricity grid and the maintenance interventions.
- Low consumption, perfectly compatible with the continuous work round-the-clock.
- Mechanical by-pass, 100% filtered, for natural ventilation (free-cooling) during summer nights.
- Possibility of integration in home automation environments through the ModBus communication protocol.
- High comfort of use even at low temperatures, thanks to the efficient heat exchanger and the effective defrosting system (pre-heater available as an option).
- Full compliance with the PassiveHause requirements.

## PERFORMANCE AND ABSORPTION

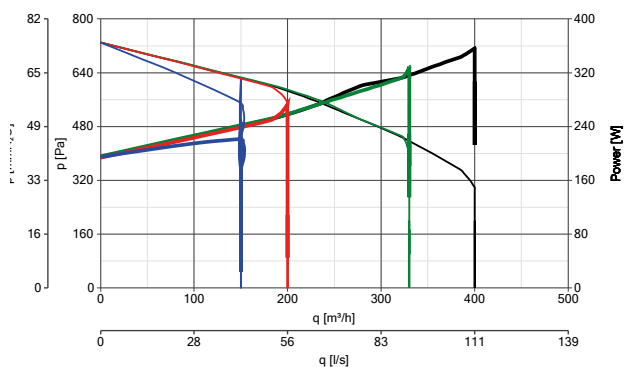

## TECHNICAL DATA

CODE	Nom. Ø (mm)	(m <sup>3</sup> /h)	(W)	(PA)	Lp [db(A)] 3m
12101	160	400	350	680	-

CONSUMPTION CURVES      PERFORMANCE CURVES

— Min.                              — Min.  
 — Avg.                              — Avg.  
 — Max.                              — Max.  
 — Boost                              — Boost

## DIMENSIONS

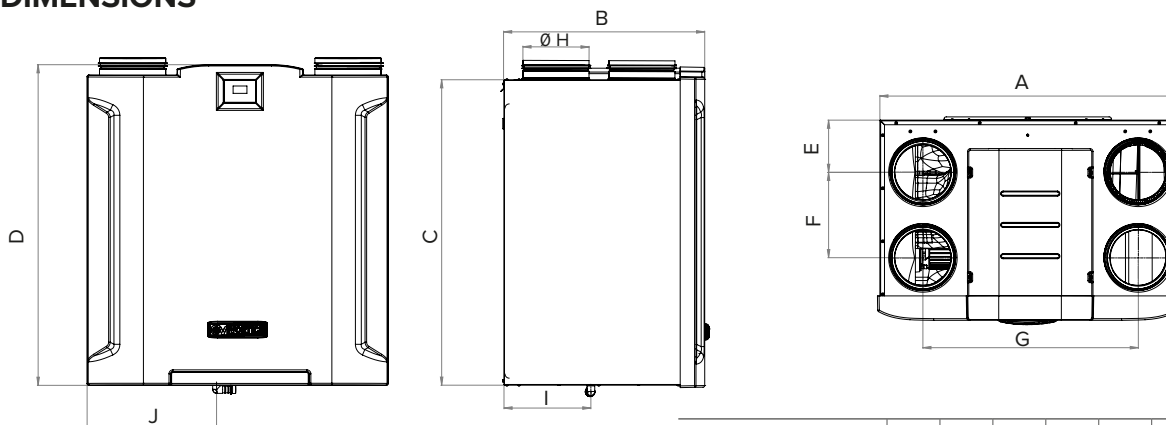

PRODUCTS	A	B	C	D	E	F	G	ØH	I	J
VORT HR 450 AVEL D	708	480	730	766	125	205	516	158	207	306

Dimensions in mm





## ENERGY DATA

	UNIT OF MEASUREMENT	VORT HR 450 AVEL D
MANUFACTURER'S NAME OR TRADE NAME	-	VORTICE
CLASS OF SPECIFIC ENERGY CONSUMPTION FOR TEMPERATE CLIMATE	-	A
SPECIFIC ENERGY CONSUMPTION SEC (COLD CLIMATE)	kWh/m <sup>2</sup> year	-75
SPECIFIC ENERGY CONSUMPTION SEC (TEMPERATE CLIMATE)		-37
SPECIFIC ENERGY CONSUMPTION SEC (WARM CLIMATE)		-12
DECLARED TYPE OF THE VENTILATION UNIT	-	UVR-B**
DRIVE TYPE	-	VSD***
HRS HEAT EXCHANGER TYPE	-	recovery
THERMAL EFFICIENCY OF HEAT RECOVERY AT THE HRS REFERENCE FLOW RATE	%	88
MAXIMUM FLOW RATE	m <sup>3</sup> /h	400
TOTAL ELECTRIC POWER ABSORBED BY THE FAN AT MAXIMUM FLOW RATE	w	258.5
NOISE LEVEL	LWA [dB(A)]	47.2
REFERENCE FLOW RATE	m <sup>3</sup> /s	0.0778
REFERENCE PRESSURE DIFFERENCE	Pa	50
SPI****	W/(m <sup>3</sup> /h)	0,384
CTRL CONTROL FACTOR	-	0.85
CONTROL TYPE	-	centralised env.
MAXIMUM PERCENTAGE OF INTERNAL LEAKAGE	%	0.3
MAXIMUM PERCENTAGE OF EXTERNAL LEAKAGE	%	0.6
MIXING RATE	-	NA*
VISUAL FILTER SIGNAL POSITION AND DESCRIPTION	-	see instruction booklet
AIR FLOW SENSITIVITY TO PRESSURE VARIATIONS AT ± 20 PA	-	NA*
INDOOR/OUTDOOR AIR TIGHTNESS	m <sup>3</sup> /h	NA*
AEC ANNUAL ELECTRICITY CONSUMPTION	kWh of electricity/ year	393
TEMPERATE AHS ANNUAL HEATING SAVING	kWh of primary energy/ year	4576
COLD AHS ANNUAL HEATING SAVING		8951
WARM AHS ANNUAL HEATING SAVING		2069



\* NA: Not applicable. \*\* UVR-U: Residential Ventilation Unit - Unidirectional. \*\*\* VM: Multiple speeds. VSD: Variable Speed Drive.

\*\*\*\* SPI: Specific power input. UVR-B\*\*: Bldirectional

## TECHNICAL FEATURES

- Zinc-coated and painted steel sheet casings. Brackets for wall installation included in the standard equipment.
- Aesthetic front panel made of plastic resin (ABS). Internal parts made of resin (PPE)
- **Intake and delivery spigots** compatible with pipes with 160 mm nominal diameter.
- **Pair of motor fans** driven by EC (brushless) motors of the external rotor type controlled at constant flow; shafts mounted on ball bearings to ensure a virtually "maintenance free" operation, directly coupled to forward curved centrifugal impellers. 4 operating speeds, independently settable upon installation.
- **High-efficiency heat exchanger**, of the cross-flow type with counterflow, made of plastic resin.
- **Automatic-activation anti-frost protection**, to prevent the formation of frost at the heat exchanger.
- **100% by-pass**, of the mechanical type, automatically operated and filtered.
- **Control panel with LCD display, for:**
  - switching on and off.
  - initial configuration of the product.
  - choosing the operating speed.
  - weekly setting of the operating mode.
  - the correct operation of the product (any malfunctions are highlighted through error messages shown on the display).
  - displaying the operating status (set speed, by-pass status, defrosting procedure active, any pre-heater and/or post-heater on, etc.).
  - signalling the saturated filters condition on the display.
- **Three ISO Coarse 90% (G4) class filters**, placed on the extraction duct, on the air delivery duct and on the by-pass respectively (ePM10 50% M5 and ePM1 55% F7 filters available as an option for the delivery duct and for the by-pass), easily accessible for periodic maintenance interventions.
- **Condensate collection tray** with drain device.
- **Possibility of interlocking with external environmental sensors** (optional), to switch to the automatic control of the operating mode.

## REGULATORS

MODELS	DESCRIPTION	DIMENSIONS	CODE	VORT HR 450 AVEL D code 12101
	<b>C SMOKE</b> Polluted air detector	144x54x55.8	12993	✓
	<b>C HCS</b> Humidity detector	144x54x55.8	12994	✓
	<b>CB LCD D</b> Wired remote control unit with LCD display for VORTICE heat recovery units. Recessed installation in a standard DIN box.	-	21381	✓





## TECHNICAL DATA

PRODUCTS	CODE	V~50 HZ	W max	A max	MAX FLOW RATE		MAX PRESSURE		°C* MAX	KG
					m <sup>3</sup> /h	l/s	mmH <sub>2</sub> O	Pa		
VORT HR 450 AVEL D	12101	220-240	350	2.75	400	110	69	680	40	40

\* Maximum temperature with continuous operation of the product.

## ACCESSORIES

MODELS	DESCRIPTION	CODE	VORT HR 450 AVEL D code 12101
	<p><b>ELECTRIC HEATER 1200</b></p> <p>Electric pre-heater. Wiring box and tubular duct, 160 mm diameter, made of zinc-coated metal sheet, stainless steel armoured electric resistors.</p> <p>Safety thermostat pre-set at 60 °C and connected in series with a manual reset thermostat set at 120 °C, single-phase power supply 1200 W.</p> <p>Designed to be electronically controlled by the combined product electronics.</p>	<b>21622</b>	✓
	<p><b>ELECTRIC HEATER 2400</b></p> <p>Electric pre-heater. Wiring box and tubular duct, 160 mm diameter, made of zinc-coated metal sheet, stainless steel armoured electric resistors.</p> <p>Safety thermostat pre-set at 60 °C and connected in series with a manual reset thermostat set at 120 °C, single-phase power supply 2400 W.</p> <p>Designed to be electronically controlled by the combined product electronics.</p>	<b>21623</b>	✓
	<p><b>NA 160 PHI</b></p> <p>Sound attenuator for circular ducts. Length 900 mm, connection diameter 160 mm.</p> <p>Suitable for installation in ventilation systems in presence of non-dusty air free of impurities, greases, chemical vapours. Casings made of zinc-coated steel sheet, mineral wool insulation, thickness 100 mm. Internal coating with micro-stretched sheet metal and glass fiber gauze film.</p> <p>Max. air speed 15 m/s.</p>	<b>21643</b>	✓

## FILTERS

MODELS	DESCRIPTION	DIMENSIONS	CODE	VORT HR 450 AVEL D code 12101
	<b>FTR ISO Coarse 90% (G4)</b>	<b>400x200x5</b>	<b>21628</b>	✓
	<b>FTR ISO Coarse 90% (G4)</b>	<b>420X59X5</b>	<b>21629</b>	✓
	<b>FTR ePM1 55% (F7)</b>	<b>398X184X21</b>	<b>21624</b>	✓
	<b>FTR ePM10 50% (M5)</b>	<b>398X184X21</b>	<b>21625</b>	✓
	<b>FTR ePM1 55% (F7)</b>	<b>420X54X21</b>	<b>21626</b>	✓
	<b>FTR ePM10 50% (M5)</b>	<b>420X54X21</b>	<b>21627</b>	✓

# VORT PROMETEO PLUS RANGE

HEAT RECOVERY UNIT



CENTRALISED VENTILATION

WALL AND FLOOR INSTALLATION

UP TO 240 M<sup>2</sup>

Centralised dual-flow unit with heat recovery for horizontal and vertical floor and wall installation, ideal for ventilation of homes as well as residential and commercial premises with a surface of up to 240 m<sup>2</sup>.



- Internal and external structure in high-density (40 kg/m<sup>3</sup>) expanded polypropylene.
- Connection spigots to pipes with 150 mm nominal diameter, centrifugal fans with backward curved blades directly coupled to EC motors.
- High-efficiency counterflow heat exchanger made of plastic material (PS).
- Automatic mechanical by-pass for free-cooling.
- Pair of Class ePM10 (M5) 50% (F5) filters
- Automatic anti-frost function, temperature, relative humidity and CO<sub>2</sub> concentration probes.
- RF radio control and silencer included.
- Floor or wall installation. Can be integrated into residential home automation systems (ModBus protocol) on RS485 SLAVE mode.

44

## PERFORMANCE AND ABSORPTION

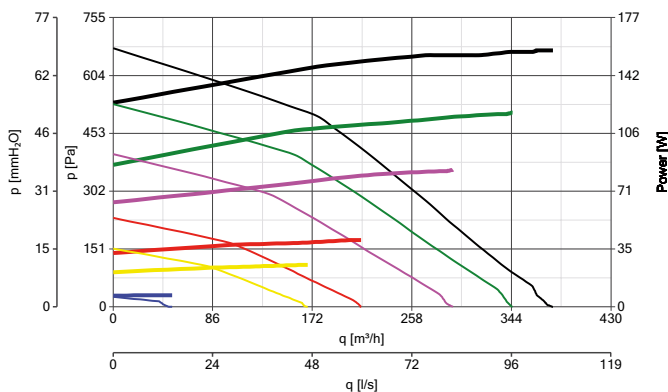

## TECHNICAL DATA

CODE	Nom. Ø (mm)	(m <sup>3</sup> /h)	(W)	(PA)	Lp [db(A)] 3m
11582	150	380	160	675	41

- 700 RPM
- 1600 RPM
- 2100 RPM
- 2650 RPM
- 3000 RPM
- 3350 RPM

## DIMENSIONS

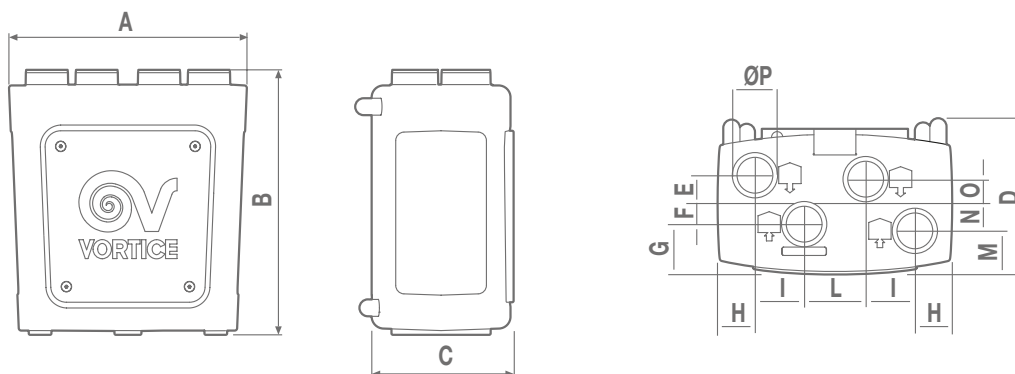

PRODUCTS	A	B	C	D	E	F	G	H	I	L	M	N	O	ØP
VORT PROMETEO PLUS HR 400	840	935	502	560	85	100	156.7	133.6	176	220	180.7	76	99	150

Dimensions in mm



## NOISE LEVELS

RPM		Lw db(A)							Lw db(A)	Lw dB (A)
		125 Hz	250 Hz	500 Hz	1000 Hz	2000 Hz	4000 Hz	8000 Hz		3m*
700	Delivery	8.4	9.3	14.0	22.6	5.0	9.2	10.1	28.0	7.5
	Intake	5.7	15.0	18.1	16.4	13.9	12.2	7.5	27.5	7.0
	Casing	14.3	39.2	18.3	20.6	2.9	7.1	na**	44.0	23.5
1600	Delivery	18.5	24.1	29.4	37.5	24.8	15.6	13.3	43.2	22.7
	Intake	16.0	25.6	27.9	28.4	18.8	6.8	3.3	37.6	17.1
	Casing	21.7	31.9	38.3	34.0	23.8	11.8	7.5	48.4	27.9
2100	Delivery	16.9	32.3	36.6	48.3	35.8	24.7	10.2	56.7	36.2
	Intake	14.9	34.7	32.8	38.4	29.2	15.7	na**	46.4	25.9
	Casing	24.6	41.1	41.6	47.1	34.8	20.8	5.6	58.0	37.5
2650	Delivery	20.3	40.9	46.0	64.7	41.8	33.7	18.5	65.5	45.0
	Intake	19.1	42.5	38.4	60.0	36.0	25.6	13.8	60.7	40.2
	Casing	31.3	43.0	48.1	59.2	41.4	29.1	13.6	61.3	40.8
3000	Delivery	23.5	41.3	47.5	52.0	44.1	37.1	22.8	59.4	38.9
	Intake	19.7	42.7	40.6	43.2	38.0	27.1	12.2	53.6	33.1
	Casing	28.9	45.7	47.9	47.4	43.9	33.3	16.2	59.5	39.0
3350	Delivery	25.3	44.4	49.7	54.8	48.4	42.3	28.8	62.7	42.2
	Intake	23.6	43.4	43.2	45.7	41.5	31.6	13.5	55.5	35.0
	Casing	31.8	46.7	51.5	55.2	47.5	37.4	22.0	62.4	41.9

\* Acoustic pressure calculated at 3 m in free field in compliance with ISO 9614.

## ENERGY DATA

45

	UNIT OF MEASUREMENT	VORT PROMETEO PLUS HR 400
MANUFACTURER'S NAME OR TRADE NAME	-	VORTICE
CLASS OF SPECIFIC ENERGY CONSUMPTION FOR TEMPERATE CLIMATE	-	A
SPECIFIC ENERGY CONSUMPTION SEC (TEMPERATE CLIMATE)	kWh/m <sup>2</sup> year	-37.6
SPECIFIC ENERGY CONSUMPTION SEC (COLD CLIMATE)		-76.1
SPECIFIC ENERGY CONSUMPTION SEC (WARM CLIMATE)		-12.9
DECLARED TYPE OF THE VENTILATION UNIT	-	UVR-B**
DRIVE TYPE	-	VSD***
HRS HEAT EXCHANGER TYPE	-	recovery
THERMAL EFFICIENCY OF HEAT RECOVERY AT THE HRS REFERENCE FLOW RATE	%	88.3
MAXIMUM FLOW RATE	m <sup>3</sup> /h	340
TOTAL ELECTRIC POWER ABSORBED BY THE FAN AT MAXIMUM FLOW RATE	w	156.0
NOISE LEVEL	LWA [dB(A)]	62
REFERENCE FLOW RATE	m <sup>3</sup> /s	0.0661
REFERENCE PRESSURE DIFFERENCE	Pa	118
SPI****	W/(m <sup>3</sup> /h)	0.34454
CTRL CONTROL FACTOR	-	0.85
CONTROL TYPE	-	centralised env.
MAXIMUM PERCENTAGE OF INTERNAL LEAKAGE	%	1.2
MAXIMUM PERCENTAGE OF EXTERNAL LEAKAGE	%	3.2
MIXING RATE	-	NA*
VISUAL FILTER SIGNAL POSITION AND DESCRIPTION	-	see instruction booklet
AIR FLOW SENSITIVITY TO PRESSURE VARIATIONS AT ± 20 PA	-	NA*
INDOOR/OUTDOOR AIR TIGHTNESS	m <sup>3</sup> /h	NA*
AEC ANNUAL ELECTRICITY CONSUMPTION	kWh of electricity/year	357
TEMPERATE AHS ANNUAL HEATING SAVING	kWh of primary energy/year	4584
COLD AHS ANNUAL HEATING SAVING		8967
WARM AHS ANNUAL HEATING SAVING		2073

\* NA: Not applicable. \*\* UVR-U: Residential Ventilation Unit - Unidirectional. \*\*\* VM: Multiple speeds. VSD: Variable Speed Drive.

\*\*\*\* SPI: Specific power input.

**VORT PROMETEO PLUS RANGE**  
HEAT RECOVERY UNIT

## TECHNICAL FEATURES

---

- **1 model.**
- **Fire-resistant expanded polypropylene casing** (DIN EN 13501). Brackets for wall installation included in the standard equipment.
- **Front panel made of plastic resin** loaded with panels for direct access to the filters.
- **Intake** and delivery spigots compatible with pipes with 150 mm nominal diameter.
- **Pair of motor fans driven by EC (brushless) motors** of the external rotor type, with shafts mounted on ball bearings, directly coupled to backward curved centrifugal impellers to guarantee high aerodynamic efficiency. 3 operating speeds, independently settable upon installation.
- **High-efficiency heat exchanger**, of the cross-flow type with counterflow, made of plastic resin (PS).
- **100% by-pass** with automatic or manual control.
- **Equipped with bidirectional remote control** with radio frequency for initial setting, selection of the operating mode, and product diagnostics.
- Equipped with **Temperature + Relative Humidity (RH) sensor and CO<sub>2</sub>** sensor whose readings enable the automatic adjustment of the operating speed for the best balance between ambient air quality, consumption, and noise emissions
- Automatic control of the filter clogging status.
- **Condensate drain tube**
- **Small connection pipe for drain tube**
- **Silencer**, with 150 mm nominal diameter and 0.5 m long, to be positioned downstream of the product, on the delivery pipe
- **Automatic anti-frost protection**, to prevent the formation of frost at the heat exchanger.
- **Pair of M5 filters** (F7 filter available as an option for the delivery duct), easily accessible for periodic maintenance.
- **Safety certified by a third party** (CE)
- **Degree of protection from dust and water:** IPX2.
- **Electrical insulation class:** II (earthing not required).

## TECHNICAL DATA

---

PRODUCTS	CODE	V~50 HZ	W max	A max	MAX FLOW RATE		MAX PRESSURE		°C* MAX	KG
					m <sup>3</sup> /h	l/s	mmH <sub>2</sub> O	Pa		
VORT PROMETEO PLUS HR 400	11582	230	160	1.3	380	106	68.8	675	50	25

\* Maximum temperature with continuous operation of the product.

## DETAILS

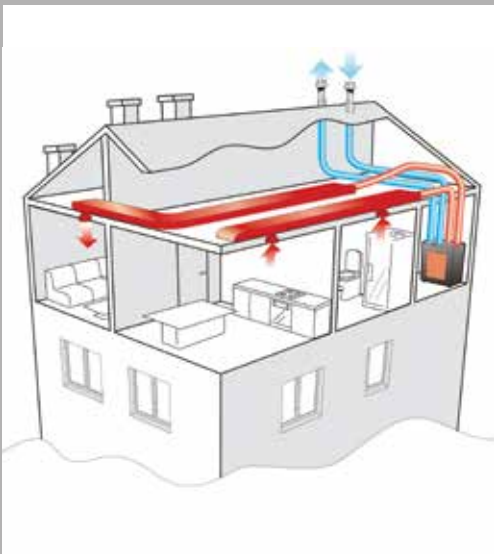
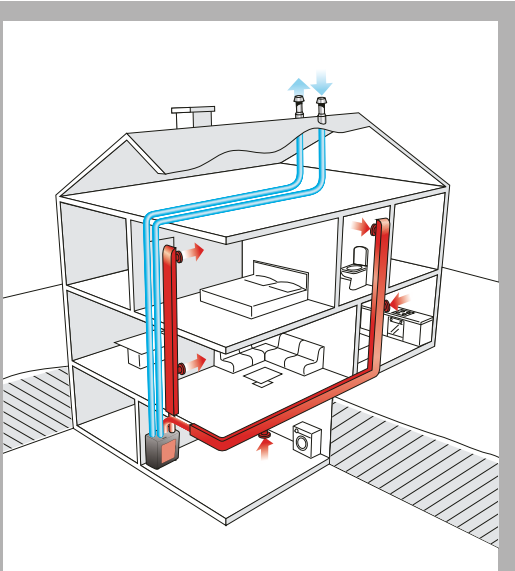

Examples of installations.



Intake and delivery spigots.



4 feet for horizontal installation supplied.

**VORT PROMETEO PLUS RANGE**  
HEAT RECOVERY UNIT

**CURVES**

EFFICIENCY IN ACCORDANCE WITH FLOW RATE

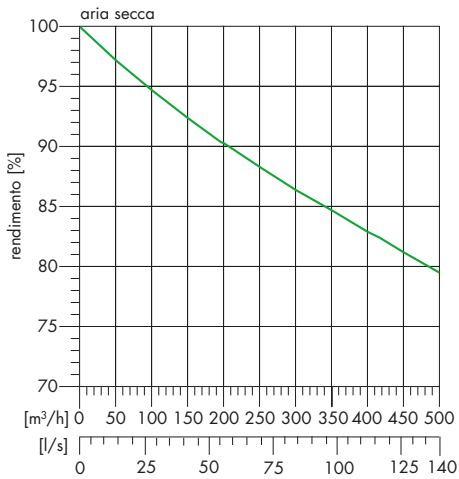

Rendimento in funzione della portata.

**RESULTS**  
(tests according to EN 308)

AIR EXTRACTION FLOW RATE (m³/h)	HEAT RECOVERY PERFORMANCE (%)
54	93
76	91
98	90
119	89
140	89
162	88
184	88
205	87



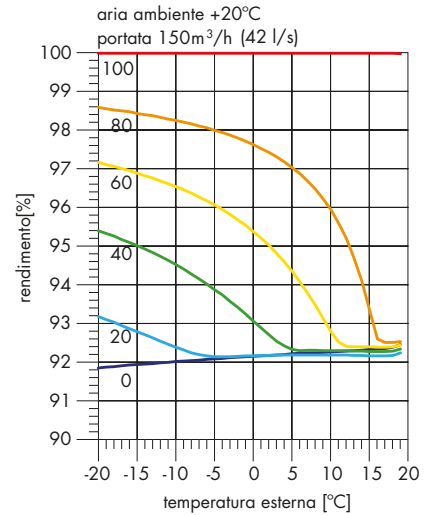

Test conditions: +5 °C/70%; +25 °C/28%.

EFFICIENCY IN ACCORDANCE WITH CONDENSATION HEAT



aria ambiente UR (%) 100 80 60 40 20 0

**ACCESSORIES**

MODELS	DESCRIPTION	DIMENSIONS	CODE	VORT PROMETEO PLUS code 11582
	REMOTE CONTROL	-	22464	✓
	EXTERNAL RF MODULE	-	22479	✓
	ELECTRIC HEATER 1200		21632	✓
	M5 FILTER		22342	✓



## FUNCTIONS AND EQUIPMENT OF THE VORT PROMETEO PLUS RANGE

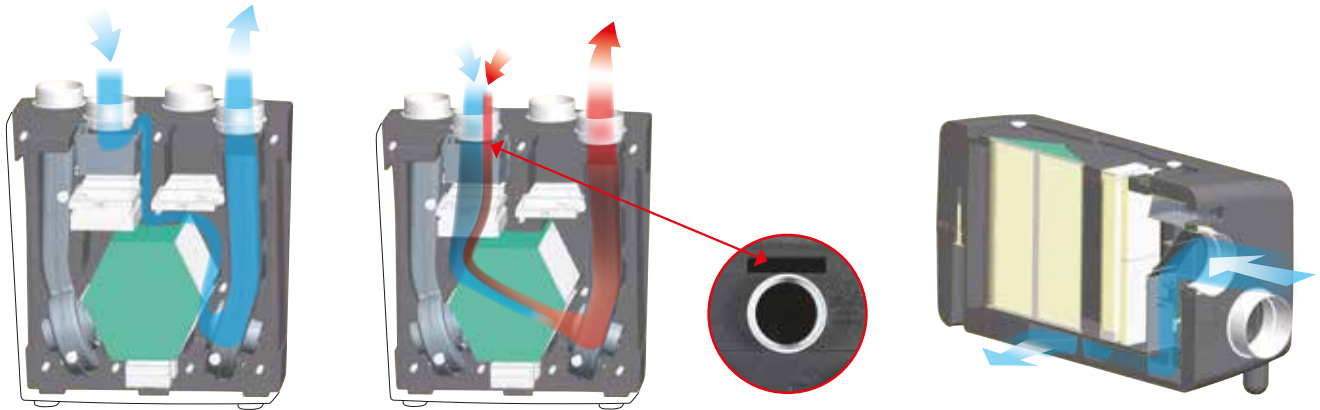

### BY-PASS

In ISOTHERMAL situations (when the temperature of the internal and external environment is the same) or external temperature coinciding with the desired internal setting, the by-pass valve is activated by excluding the exchanger and enabling direct ventilation (FREE-COOLING).

### FROST PROTECTION (DEFROSTING)

In situations where the outside air has a temperature and RH% such as to cause the formation of ice in the exchanger, the anti-frost valve is automatically activated to allow the intake of more temperate air from the environment, which, mixing with the air coming from the outside, mitigates the temperature. At the same time, an appropriate speed variation of the motors driven by the electronic control makes the defrosting action faster and more effective. In particularly harsh climates, we recommend the additional installation of a 500-W, 1200-W or 1800-W pre-heater which is automatically activated by the electronics on board.

### FILTERS

The VORT PROMETEO PLUS range is equipped with 2 F5 filters, respectively dedicated to the incoming air and to the exchanger protection. An additional optional F7 filter is available for further removal of impurities from the incoming air. An F5 filter box is also provided as an accessory to be installed outside the machine. The efficiency of the filters is monitored by the electronics on board, which visually and acoustically trigger a maintenance alarm on the RF remote control.

### FILTERS

- The air we breathe contains a large number of harmful particles; more than 90% of these particles are less than 1  $\mu\text{m}$  in size, for example: fine particles emitted by motor vehicles and heating systems; viruses; bacteria. For this reason, it is very important to use air exchange systems that are equipped with high efficiency filters, i.e. that allow the retention of most of these harmful particles.
- Controlled mechanical ventilation systems such as the VORT PROMETEO PLUS HR 400 heat recovery units filter the air entering the home and preserve the health and well-being of the people living in the premises in which the product is installed.
- Filters can be identified based on their filtration efficiency in 2 main classes: Type G: wide mesh filter and Type F: fine mesh filter. These classes are defined by the European standard EN779. Within the two classes, a progressive number indicates the efficiency level of the filter: the higher the number, the more effective the filter is in the treatment of particles, as shown in the graph below.

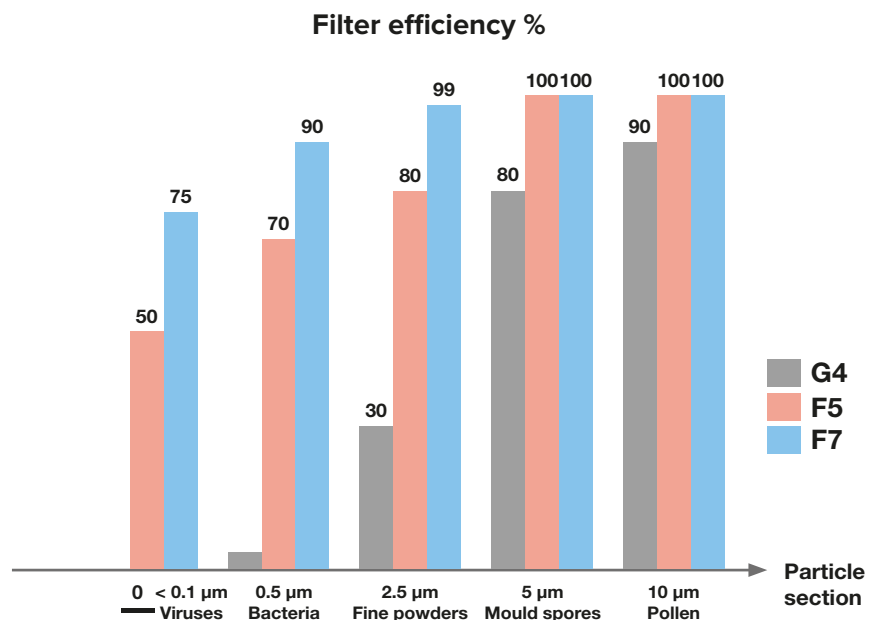

F filters are the most effective on small particles.



### DO NOT FORGET

With prolonged use, filters become clogged, increasing the pressure drops of the aerualic circuit; periodic maintenance must be carried out to replace the filters when they are exhausted.

# VORT INVISIBLE MINIRANGE

FALSE CEILING HEAT RECOVERY UNIT



**CEILING VENTILATION**

**UP TO 80 M<sup>2</sup>**

Centralised dual-flow ventilation unit with heat recovery for false ceiling installation, specifically designed for the ventilation of small apartments, offices, and hotel rooms, with a surface of up to 80 m<sup>2</sup>.



- Suitable for false ceiling installation.
- Casing made of white painted steel sheet.
- Easy wiring, all main components are easily accessible from the bottom of the product.
- Universal duct connection Ø100 to 125 mm.
- Recovers almost 90% of the thermal energy of the extracted air, which is transferred to the fresh air at zero cost.
- Wired remote LCD control panel.
- Mechanical by-pass, 100% filtered, automatically operated.
- Full compatibility with 24/7 continuous operation, thanks to low consumption.

## PERFORMANCE AND ABSORPTION

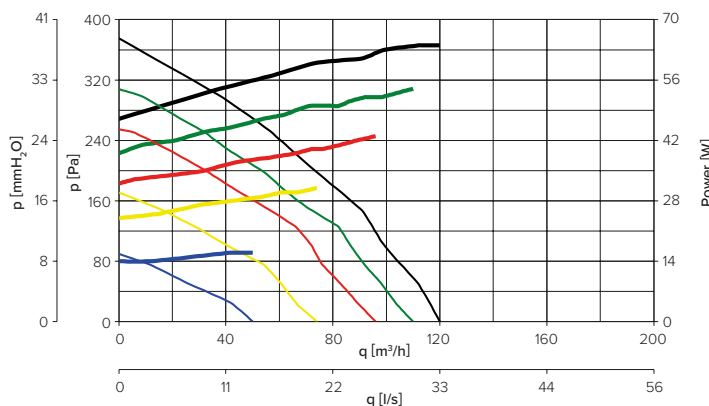

## TECHNICAL DATA

PRODUCT	CODE	Nom. Ø (mm)	(m <sup>3</sup> /h)	(W)	(PA)	Lp [dB (A)] 3m
VORT INVISIBLE MINI TOP	12219	100-125	120	64	375	36

- Max speed
- 100% adjustment
- 90% adjustment
- 80% adjustment
- 60% adjustment
- 40% adjustment

## DIMENSIONS

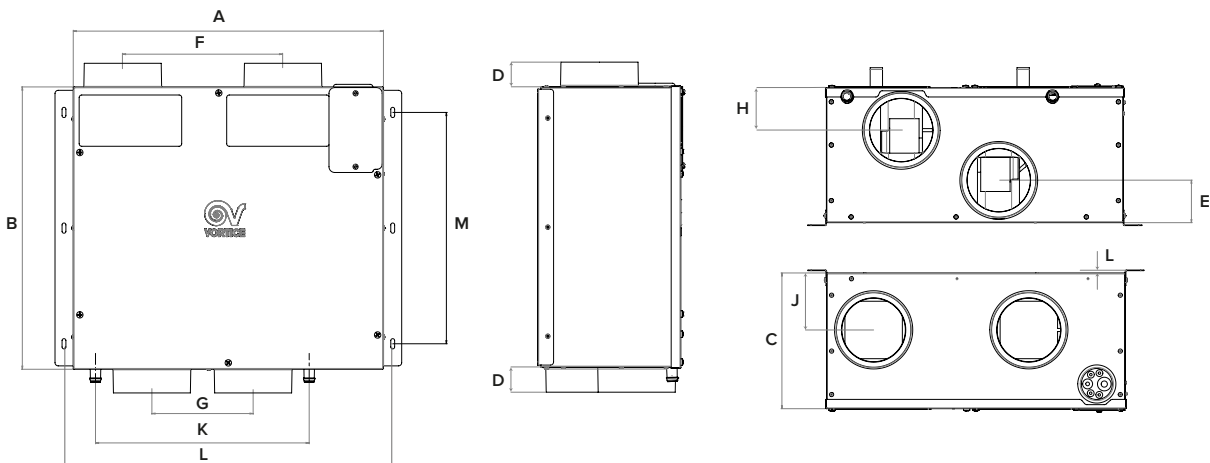

Dimensions in mm

PRODUCTS	A	B	C	D	E	F	G	H	I	J	K	L	M
VORT INVISIBLE MINI TOP	484	440.5	218	40	40	250	158	69	69	92	361	513	66

Connection ports to the intake and delivery pipes compatible with 100 mm and 125 mm nominal diameters



## ENERGY DATA

	UNIT OF MEASUREMENT	VORT INVISIBLE MINI TOP
MANUFACTURER'S NAME OR TRADE NAME	-	VORTICE
CLASS OF SPECIFIC ENERGY CONSUMPTION FOR TEMPERATE CLIMATE	-	A
SPECIFIC ENERGY CONSUMPTION SEC (TEMPERATE CLIMATE)	kWh/m <sup>2</sup> year	-35
SPECIFIC ENERGY CONSUMPTION SEC (COLD CLIMATE)		-73
SPECIFIC ENERGY CONSUMPTION SEC (WARM CLIMATE)		-10
DECLARED TYPE OF THE VENTILATION UNIT	-	UVR-B**
DRIVE TYPE	-	VSD
HRS HEAT EXCHANGER TYPE	-	recovery
THERMAL EFFICIENCY OF HEAT RECOVERY AT THE HRS REFERENCE FLOW RATE	%	87
MAXIMUM FLOW RATE	m <sup>3</sup> /h	100
TOTAL ELECTRIC POWER ABSORBED BY THE FAN AT MAXIMUM FLOW RATE	w	63
NOISE LEVEL	LWA [dB(A)]	46
REFERENCE FLOW RATE	m <sup>3</sup> /s	0.0194
REFERENCE PRESSURE DIFFERENCE	Pa	60
SPI****	W/(m <sup>3</sup> /h)	0,457
CTRL CONTROL FACTOR	-	0.85
CONTROL TYPE	-	centralised env.
MAXIMUM PERCENTAGE OF INTERNAL LEAKAGE	%	3.0
MAXIMUM PERCENTAGE OF EXTERNAL LEAKAGE	%	3.0
MIXING RATE	-	NA*
VISUAL FILTER SIGNAL POSITION AND DESCRIPTION	-	see instruction booklet
AIR FLOW SENSITIVITY TO PRESSURE VARIATIONS AT ± 20 PA	-	NA*
INDOOR/OUTDOOR AIR TIGHTNESS	m <sup>3</sup> /h	NA*
AEC ANNUAL ELECTRICITY CONSUMPTION	kWh of electricity/year	459
TEMPERATE AHS ANNUAL HEATING SAVING	kWh of primary energy/year	4548
COLD AHS ANNUAL HEATING SAVING		8898
WARM AHS ANNUAL HEATING SAVING		2057

\*NA: Not Applicable

\*\*UVR-U: Residential Ventilation Unit - Unidirectional

\*\*\* UVR-B: Residential Ventilation Unit - Bidirectional

\*\*\*\*VM: Multiple speeds. VSD: Variable Speed Drive

\*\*\*\*\*SPI: Specific power intake

**VORT INVISIBLE MINI RANGE**  
FALSE CEILING HEAT RECOVERY UNIT

## TECHNICAL FEATURES





- **Casing made of zinc-coated white painted steel sheet.** Brackets, made of zinc-coated painted steel sheet, necessary for the suspended installation of the appliance, supplied as standard.
- Connection ports for extraction and delivery pipes with 100 mm and 125 mm nominal diameter.
- Condensate collection tank, complete with “overflow” sensor to avoid the risk of overflows.
- **Pair of 3-speed centrifugal fans** driven by EC (brushless) motors (low consumption), independently adjustable.
- **High-efficiency heat exchanger**, made of plastic resin, of the cross-flow with counterflow type.
- **Mechanical by-pass**, filtered, automatically operated.
- Multiple grommet, in compliance with UNI EN 60335-2-80 international safety standards.
- Pair of ISO COARSE 45% (G3) filters, in correspondence of the extraction/delivery ducts .
- Condensate collection tank made of plastic resin, complete with “overflow” sensor to avoid the risk of condensate overflows.
- Cross-flow counterflow heat exchanger.

## TECHNICAL DATA

PRODUCTS	CODE	V~50 HZ	W		A		RPM		MAX FLOW RATE		MAX PRESSURE		IP	KG
			min/max	min/max	min/max	min/max	m <sup>3</sup> /h min/max	l/s min/max	mmH <sub>2</sub> O	Pa				
VORT INVISIBLE MINI TOP	12219	220-240	16 64	0.30 0.65	1830 3900	50 120	50 120	38.2	375	X2	14			

\* Maximum temperature with continuous operation of the product.

## ACCESSORIES

MODELS	DESCRIPTION	DIMENSIONS	CODE	VORT INVISIBLE MINI TOP code 12219
	<b>C SMOKE</b> Smoke detector	<b>144x54x55.8</b>	<b>12993</b>	✓
	<b>C HCS</b> Humidity detector	<b>116x83x75</b>	<b>12994</b>	✓
	<b>C PIR</b> Humidity detector	<b>144x54x55.8</b>	<b>12998</b>	✓
	<b>SCP DIN</b> Flush mounting box		<b>12898</b>	✓

## CONTROL UNIT SUPPLIED

- Wired connection
- Compatible with standard DIN flush-mounted box



### LCD display

Provides the following displays:

- Set relative humidity threshold
- Activation of the defrosting procedure (defrost)
- Saturated filters
- Error codes



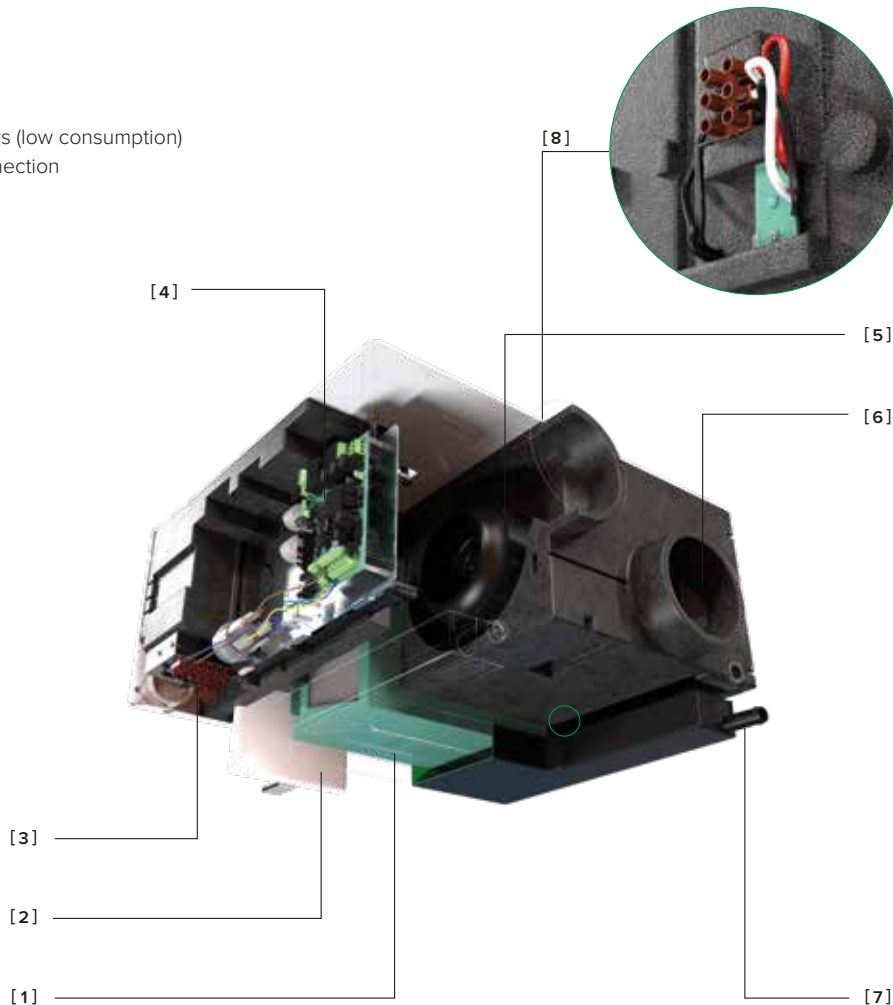

## DETAILS

- [1] Heat exchanger
- [2] Filter
- [3] Terminal block
- [4] Electronic board
- [5] EC Brushless motors (low consumption)
- [6] Universal duct connection
- [7] Condensate drain
- [8] HCS sensor



**VORT INVISIBLE MINI RANGE**  
FALSE CEILING HEAT RECOVERY UNIT

**FILTERS**

MODELS	DESCRIPTION	DIMENSIONS	CODE	VORT INVISIBLE MINI TOP code 12214
	ISO Coarse 45% (G3)	206x132x5	21805	✓
	ISO Coarse 65% (G4)	206x132x5	21806	✓
	ePM10 50% (M5)	208x127x25	21802	✓
	ePM1 55% (F7)	208x127x25	21803	✓
	ePM1 80% (F9)	208x127x25	21804	✓

**SYSTEM COMPONENTS**

MODEL	DESCRIPTION	CODE
	<p style="text-align: center;"><u>Pre-heater</u></p> <p>“Pre-heater to prevent the formation of frost in collaboration with the heat exchanger, also required in harsh climates. 500 W Yield”</p>	21805
	<p style="text-align: center;"><u>Post-heater</u></p> <p>“Electric post-heater useful for optimising the efficiency of the controlled mechanical ventilation system. 500 W Yield”</p>	21806



## Air flows

### Winter/Summer mode

The fresh air, passing through the heat exchanger, heats due to the effect of the interaction with the extracted stale air, thus ensuring adequate ventilation without unnecessary energy waste.

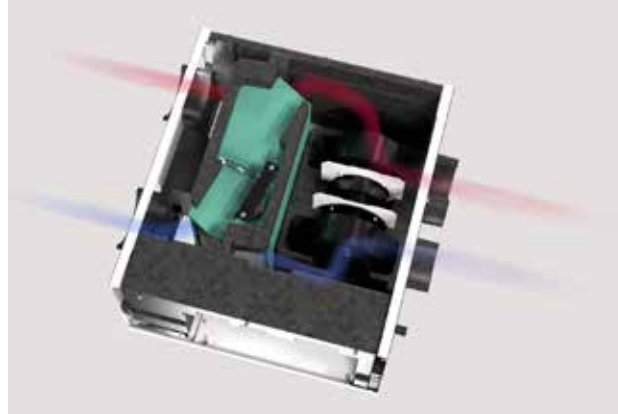

### Free cooling mode

The fresh air, passing through the heat exchanger, cools down due to the effect of the interaction with the extracted stale air, thus ensuring adequate ventilation without unnecessary energy waste.

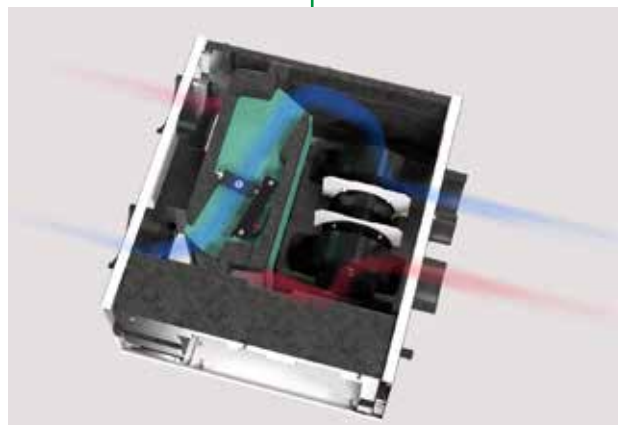

#### **BY-PASS FUNCTION**

When climatic conditions require (for example on cool summer evenings) the introduction of outside air. At the original temperature, the opening of the by-pass damper allows the incoming flow to get around the heat exchanger, ensuring the exchange of air with maximum comfort.

# VORT HRI FLAT RANGE

FALSE CEILING HEAT RECOVERY UNITS



**FALSE CEILING CENTRALISED**

**VENTILATION**

**UP TO 240 M<sup>2</sup>**

Centralized dual flow ventilation units with heat recovery for false ceiling. The ideal balance between performance, functions, and purchase and operating costs makes the VORT HRI FLAT range the most cost-effective solution for the ventilation of homes as well as residential and commercial premises with an area of up to 90 m<sup>2</sup> (VORT HRI 200 FLAT) or 240 m<sup>2</sup> (VORT HRI 350 FLAT), featuring high levels of thermal insulation.



- Suitable for false ceiling installation.
- Self-supporting casing made of (10/10) zinc-coated metal sheet, with internal sound-absorbing coating.
- Connection spigots to pipes with 125 mm (FLAT200) and 150 mm (FLAT350) nominal diameter, centrifugal fans with backward blades directly coupled to EC motors.
- High-efficiency heat exchanger of the counterflow type made of plastic material (PS).
- Automatic thermodynamic bypass, based on the temperature probes available in the machine.
- Pair of Class ePM10 (M5) 50% (F5) filters.
- Three-speed control panel supplied as standard, suitable for a 503 box.

## PERFORMANCE AND ABSORPTION

## TECHNICAL DATA

PRODUCTS	CODE	Nom. Ø (mm)	(m <sup>3</sup> /h)	(W)	(PA)	Lp [dB (A)] 3m
VORT HRI 200 FLAT	11281	125	206	102	426	22.8
VORT HRI 350 FLAT	11282	150	380	250	550	16.7

VORT HRI 200 FLAT

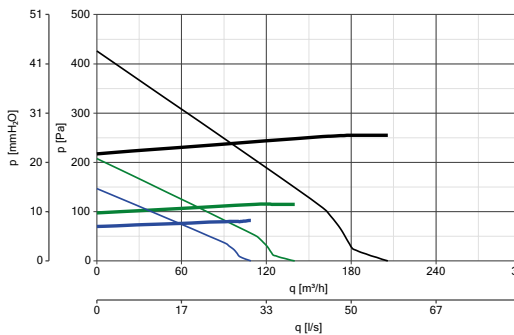

VORT HRI 350 FLAT

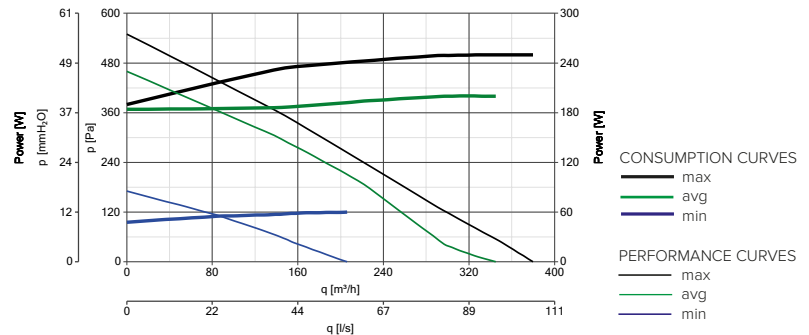

## DIMENSIONS

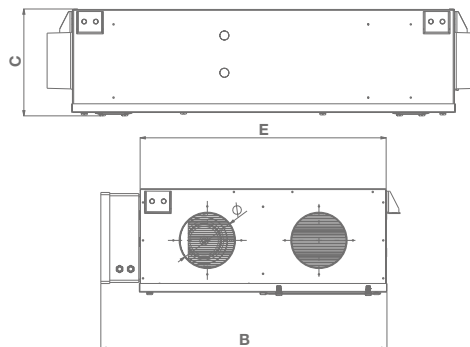
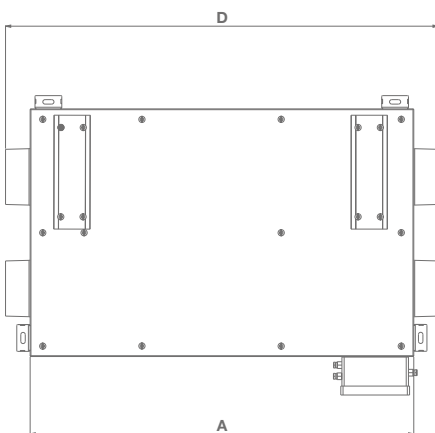

Dimensions in mm

PRODUCTS	CODE	A	B	C	D	E	Ø
VORT HRI 200 FLAT	11281	860	643	240	969	551	125
VORT HRI 350 FLAT	11282	1183	740	288	1287	650	150





## NOISE LEVELS

VORT HRI 200 FLAT		Lw db(A)							Lw db(A)	Lw dB (A)
		125 Hz	250 Hz	500 Hz	1000 Hz	2000 Hz	4000 Hz	8000 Hz	3m*	
MIN. SPEED	Delivery	22.7	31.4	17.4	14.9	10.1	na**	na**	43.3	22.8
	Intake	24.2	36.8	23.0	15.4	14.0	7.3	na**	36.5	16.0
	Casing	35.7	36.9	29.2	22.2	17.0	9.8	na**	43.1	22.6

VORT HRI 350 FLAT		Lw db(A)							Lw db(A)	Lw dB (A)
		125 Hz	250 Hz	500 Hz	1000 Hz	2000 Hz	4000 Hz	8000 Hz	3m*	
MIN. SPEED	Delivery	16.7	27.4	24.3	17.1	16.9	7.1	na**	37.2	16.7
	Intake	16.3	32.1	22.2	11.3	15.5	6.2	na**	37.8	17.3
	Casing	33.4	35.6	41.6	38.0	37.2	30.4	27.3	51.0	30.5

\* Acoustic pressure measured at 3 m in free field with the intensimetric method in a semi-anechoic cabin at maximum speed in accordance with ISO 9614. \*\* Data not available.

## ENERGY DATA

	UNIT OF MEASUREMENT	VORT HRI 200 FLAT	VORT HRI 350 FLAT
MANUFACTURER'S NAME OR TRADE NAME	-	VORTICE	VORTICE
CLASS OF SPECIFIC ENERGY CONSUMPTION FOR TEMPERATE CLIMATE	-	A	A
SPECIFIC ENERGY CONSUMPTION SEC (TEMPERATE CLIMATE)	kWh/m <sup>2</sup> year	-36.3	-38.0
SPECIFIC ENERGY CONSUMPTION SEC (COLD CLIMATE)		-74.7	-77.0
SPECIFIC ENERGY CONSUMPTION SEC (WARM CLIMATE)		-11.7	-13.0
DECLARED TYPE OF THE VENTILATION UNIT	-	UVR-B**	UVR-B**
DRIVE TYPE	-	VSD***	VSD***
HRS HEAT EXCHANGER TYPE	-	recovery	recovery
THERMAL EFFICIENCY OF HEAT RECOVERY AT THE HRS REFERENCE FLOW RATE	%	87.8	90.4
MAXIMUM FLOW RATE	m <sup>3</sup> /h	163	280
TOTAL ELECTRIC POWER ABSORBED BY THE FAN AT MAXIMUM FLOW RATE	w	100.0	165.0
NOISE LEVEL	LWA [dB(A)]	43	51
REFERENCE FLOW RATE	m <sup>3</sup> /s	0.0317	0.0544
REFERENCE PRESSURE DIFFERENCE	Pa	50	70
SPI****	W/(m <sup>3</sup> /h)	0.39474	0.35204
CTRL CONTROL FACTOR	-	0.85	0.85
CONTROL TYPE	-	centralised env.	centralised env.
MAXIMUM PERCENTAGE OF INTERNAL LEAKAGE	%	8.5	8.7
MAXIMUM PERCENTAGE OF EXTERNAL LEAKAGE	%	8.5	5.2
MIXING RATE	-	NA*	NA*
VISUAL FILTER SIGNAL POSITION AND DESCRIPTION	-	see instruction booklet	see instruction booklet
AIR FLOW SENSITIVITY TO PRESSURE VARIATIONS AT ± 20 PA	-	NA*	NA*
INDOOR/OUTDOOR AIR TIGHTNESS	m <sup>3</sup> /h	NA*	NA*
AEC ANNUAL ELECTRICITY CONSUMPTION	kWh of electricity/ year	402	364
TEMPERATE AHS ANNUAL HEATING SAVING	kWh of primary energy/ year	4570	4641
COLD AHS ANNUAL HEATING SAVING		8940	9078
WARM AHS ANNUAL HEATING SAVING		2067	2098

\* NA: Not applicable. \*\* UVR-U: Residential Ventilation Unit - Unidirectional. \*\*\* VM: Multiple speeds. VSD: Variable Speed Drive.

\*\*\*\* SPI: Specific power input.

**VORT HRI FLAT RANGE**  
FALSE CEILING HEAT RECOVERY UNIT

## TECHNICAL FEATURES

- **2 models**, different in size and performance provided.
- **Casings made of zinc-coated steel sheet** integrating support brackets for false ceiling mounting; internal shell covered in sound-absorbing and heat-insulating fire-resistant material (DIN EN 13501). Tie-rods for suspended installation included in the standard equipment.
- **Intake and delivery spigots** compatible with pipes with 125 mm (VORT HRI 200 FLAT) and 150 mm (VORT HRI 350 FLAT) nominal diameter.
- **Pair of motor fans driven by EC motors (brushless)** of the external rotor type, with shafts mounted on ball bearings, directly coupled to backward curved centrifugal impellers to guarantee high aeraulic efficiency. 3 operating speeds, independently settable upon installation.
- **High-efficiency heat exchanger**, of the cross-flow type with counterflow, made of plastic resin (PS).
- **Automatic-activation frost protection**, to prevent the formation of frost at the heat exchanger.
- **Mechanical by-pass**, automatic and 100% filtered, to guarantee the comfort of the occupants of the rooms in mid-seasons, or whenever the outside temperature does not require the action of the heat exchanger.
- **Remote control unit**, wire connected, for:
  - switching the product on and off;
  - selecting the product's minimum, average, or maximum speed;
  - signalling, by means of an indicator light, the saturated filters condition.
- **Pair of M5 filters** (F7 filter available as an option for the delivery duct), easily accessible for periodic maintenance interventions.
- **Condensate collection tray** with drain devices.
- **Possibility of interlocking with external environmental sensors** (optional), for the automatic control of the operating mode.
- **Degree of protection from dust and water**: IPX2.
- **Electrical insulation class**: II (earthing not required).

58

## TECHNICAL DATA

PRODUCTS	CODE	V~50 HZ	W max	A max	MAX FLOW RATE		MAX PRESSURE		°C* MAX	KG
					m <sup>3</sup> /h	l/s	mmH <sub>2</sub> O	Pa		
VORT HRI 200 FLAT	11281	230	102	1.0	210	58.3	48.4	475	40	24
VORT HRI 350 FLAT	11282	230	250	2.0	380	105	56.0	550	50	33

\* Maximum temperature with continuous operation of the product.



## DETAILS

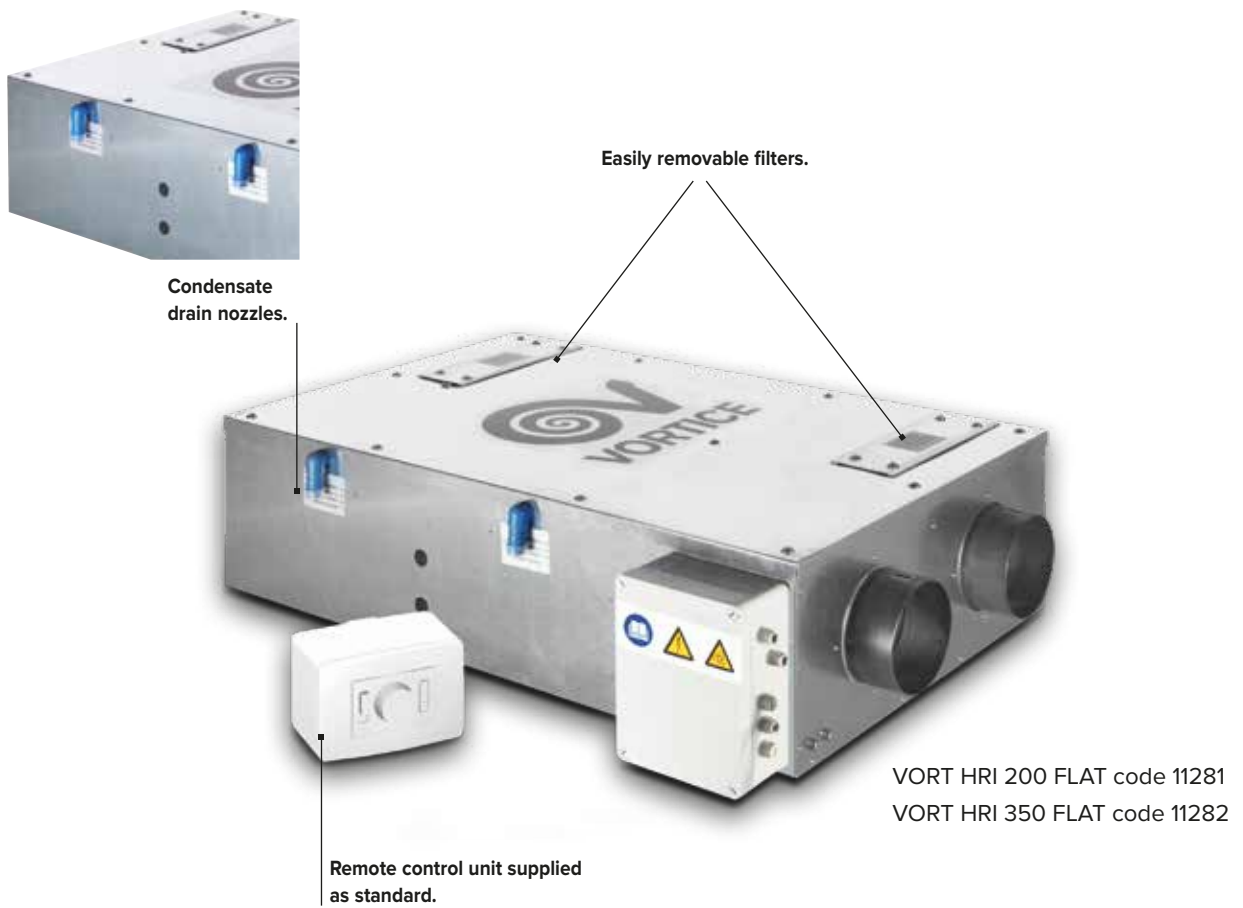

VORT HRI 200 FLAT code 11281  
VORT HRI 350 FLAT code 11282

**VORT HRI FLAT RANGE**  
FALSE CEILING HEAT RECOVERY UNIT

**EFFICIENCY CURVES**

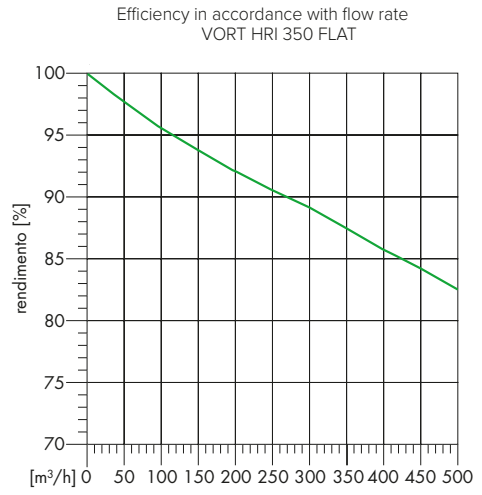
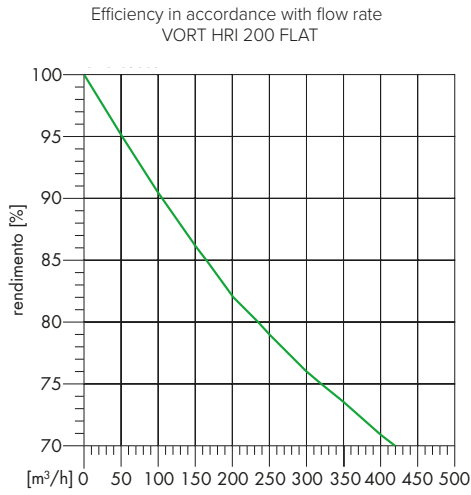

Efficiency in accordance with condensation heat

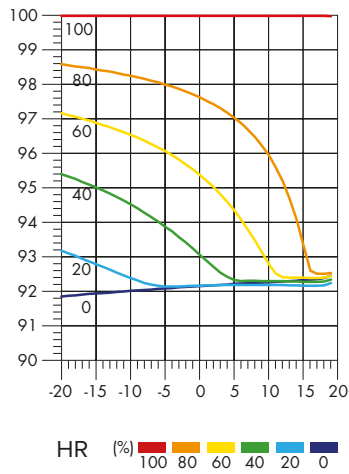

Efficiency in accordance with condensation heat

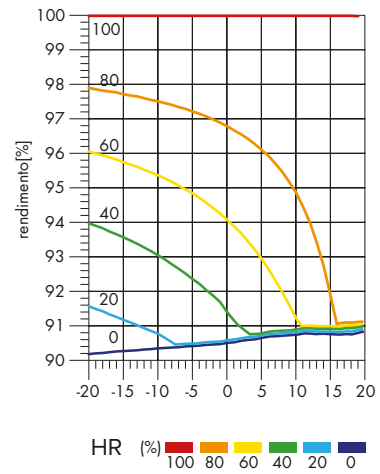



## FILTERS

MODELS	DESCRIPTION	DIMENSIONS	CODE	VORT HRI 200 FLAT code 11281	VORT HRI 350 FLAT code 11282
	<b>FILTER F7</b>	228X224X24	22625	✓	
	<b>FILTER F7</b>	230X250X48	22628		✓
	<b>FILTER M5</b>	212X227X24	22647	✓	
	<b>FILTER M5</b>	230X250X48	22646		✓

61

## ACCESSORIES

MODELS	DESCRIPTION	CODE	VORT HRI 200 FLAT code 11281	VORT HRI 350 FLAT code 11282
	<b>ELECTRIC HEATER 500</b> Pre-heater to prevent the formation of frost in correspondence of the heat exchanger, also in particularly rigid climates	21630	✓	
	<b>ELECTRIC HEATER 750</b> Pre-heater to prevent the formation of frost in correspondence of the heat exchanger, also in particularly rigid climates	22735		✓

# VORT PHANTOM RANGE

FALSE CEILING HEAT RECOVERY UNITS

**A**

**FALSE CEILING CENTRALISED**

**VENTILATION**

**UP TO 240 M<sup>2</sup>**

Dual-flow centralised ventilation units with false ceiling heat recovery, ideal for the ventilation of homes as well as residential and commercial premises.



- Suitable for false ceiling installation
- Self-supporting casing made of (10/10) zinc-coated metal sheet, with internal fire-resistant sound-absorbing coating, lower cover in ABS.
- Connection spigots to pipes with 125 mm (PHANTOM 200) and 150 mm (PHANTOM 350) nominal diameter, backward curved centrifugal fans directly coupled to EC motors.
- High-efficiency counterflow heat exchanger made of plastic material (PS).
- Automatic thermodynamic by-pass, based on the temperature probes available in the machine.
- Automatic mechanical by-pass, based on the temperature probes available in the machine (BP MODELS)
- Pair of Class ePM10 (M5) 50% (F5) filters
- Wired remote LCD control panel supplied as standard.

## PERFORMANCE AND ABSORPTION

### TECHNICAL DATA

PRODUCTS	CODE	Nom. Ø (mm)	(m <sup>3</sup> /h)	(W)	(PA)	Lp [db(A)] 3m
VORT HRI 200 PHANTOM BP	11291	125	206	102	426	22.8
VORT HRI 350 PHANTOM BP	11293	150	350	165	568	16.7

VORT HRI 200 PHANTOM BP

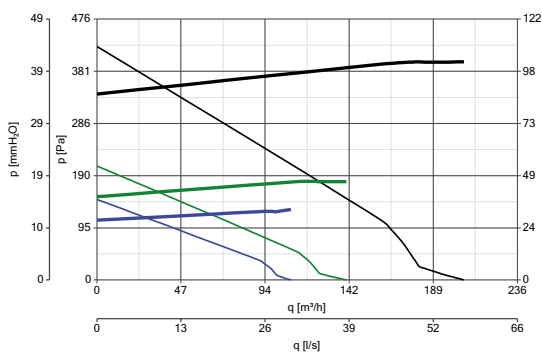

VORT HRI 350 PHANTOM BP

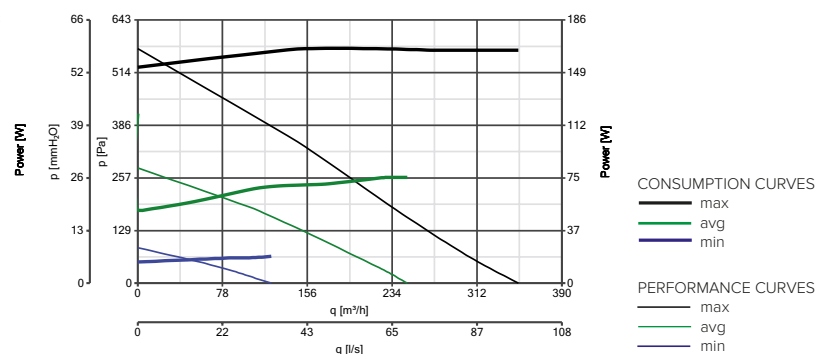

## DIMENSIONS

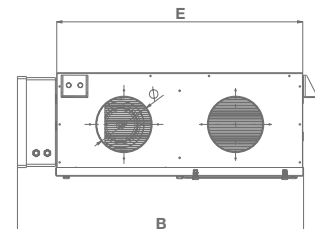
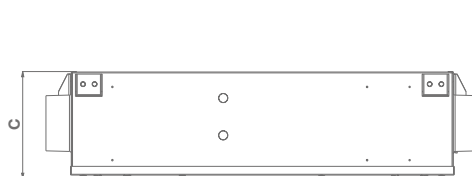
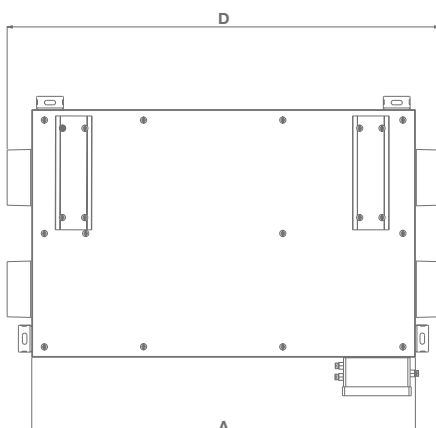

PRODUCTS	CODE	A	B	C	D	E	Ø
VORT HRI 200 PHANTOM BP	11291	868	643	248	963.5	551	125
VORT HRI 350 PHANTOM BP	11293	1183	740	288	1287	650	150

Dimensions in mm



## NOISE LEVELS

VORT HRI 200 PHANTOM BP		Lw db(A)							Lw db(A)	Lw dB (A)
		125 Hz	250 Hz	500 Hz	1000 Hz	2000 Hz	4000 Hz	8000 Hz	3m*	
MIN. SPEED	Delivery	22.7	31.4	17.4	14.9	10.1	na**	na**	43.3	22.8
	Intake	24.2	36.8	23.0	15.4	14.0	7.3	na**	36.5	16.0
	Casing	35.7	36.9	29.2	22.2	17.0	9.8	na**	43.1	22.6

VORT HRI 350 PHANTOM BP		Lw db(A)							Lw db(A)	Lw dB (A)
		125 Hz	250 Hz	500 Hz	1000 Hz	2000 Hz	4000 Hz	8000 Hz	3m*	
MIN. SPEED	Delivery	16.7	27.4	24.3	17.1	16.9	7.1	na**	37.2	16.7
	Intake	16.3	32.1	22.2	11.3	15.5	6.2	na**	37.8	17.3
	Casing	33.4	35.6	41.6	38.0	37.2	30.4	27.3	51.0	30.5

\* Acoustic pressure measured at 3 m in free field with the intensimetric method in a semi-anechoic cabin at maximum speed in accordance with ISO 9614. \*\* Data not available.

## ENERGY DATA

	UNIT OF MEASUREMENT	VORT HRI 200 PHAN-	VORT HRI 350 PHAN-
		TOM BP	TOM BP
MANUFACTURER'S NAME OR TRADE NAME	-	VORTICE	VORTICE
CLASS OF SPECIFIC ENERGY CONSUMPTION FOR TEMPERATE CLIMATE	-	A	A
SPECIFIC ENERGY CONSUMPTION SEC (TEMPERATE CLIMATE)	kWh/m <sup>2</sup> year	-36.3	-38.0
SPECIFIC ENERGY CONSUMPTION SEC (COLD CLIMATE)		-74.7	-77.0
SPECIFIC ENERGY CONSUMPTION SEC (WARM CLIMATE)		-11.7	-13.0
DECLARED TYPE OF THE VENTILATION UNIT	-	UVR-B**	UVR-B**
DRIVE TYPE	-	VSD***	VSD***
HRS HEAT EXCHANGER TYPE	-	recovery	recovery
THERMAL EFFICIENCY OF HEAT RECOVERY AT THE HRS REFERENCE FLOW RATE	%	87.8	90.4
MAXIMUM FLOW RATE	m <sup>3</sup> /h	163	280
TOTAL ELECTRIC POWER ABSORBED BY THE FAN AT MAXIMUM FLOW RATE	w	100.0	165.0
NOISE LEVEL	LWA [dB(A)]	43	51
REFERENCE FLOW RATE	m <sup>3</sup> /s	0.0317	0.0544
REFERENCE PRESSURE DIFFERENCE	Pa	50	70
SPI****	W/(m <sup>3</sup> /h)	0.39474	0.35204
CTRL CONTROL FACTOR	-	0.85	0.85
CONTROL TYPE	-	centralised env.	centralised env.
MAXIMUM PERCENTAGE OF INTERNAL LEAKAGE	%	8.5	8.7
MAXIMUM PERCENTAGE OF EXTERNAL LEAKAGE	%	8.5	5.2
MIXING RATE	-	NA*	NA*
VISUAL FILTER SIGNAL POSITION AND DESCRIPTION	-	see instruction booklet	see instruction booklet
AIR FLOW SENSITIVITY TO PRESSURE VARIATIONS AT ± 20 PA	-	NA*	NA*
INDOOR/OUTDOOR AIR TIGHTNESS	m <sup>3</sup> /h	NA*	NA*
AEC ANNUAL ELECTRICITY CONSUMPTION	kWh of electricity/ year	402	364
TEMPERATE AHS ANNUAL HEATING SAVING	kWh of primary energy/ year	4570	4641
COLD AHS ANNUAL HEATING SAVING		8940	9078
WARM AHS ANNUAL HEATING SAVING		2067	2098

\* NA: Not applicable. \*\* UVR-U: Residential Ventilation Unit - Unidirectional. \*\*\* VM: Multiple speeds. VSD: Variable Speed Drive.

\*\*\*\* SPI: Specific power input.

**VORT PHANTOM RANGE**  
FALSE CEILING HEAT RECOVERY UNIT

## TECHNICAL FEATURES

- **2 models**, different in size and performance, equipped with thermodynamic or mechanical by-pass.
- **Casings made of zinc-coated steel sheet** integrating support brackets for false ceiling mounting; internal shell covered in sound-absorbing, heat-insulating and fire-resistant material (DIN EN 13501). Tie-rods for suspended installation included in the standard equipment.
- **Thermoformed plastic resin (PP) bottom covers**, integrating the panels for direct access to the air filters.
- **Intake and delivery spigots** compatible with pipes with 125 mm (VORT HRI 200 PHANTOM) and 150 mm (VORT HRI 350 PHANTOM) nominal diameter.
- **Pair of motor fans driven by EC (brushless) motors** of the external rotor type, with shafts mounted on ball bearings, directly coupled to backward curved centrifugal impellers to guarantee high aeraulic efficiency. 3 operating speeds, independently settable upon installation.
- **High-efficiency heat exchanger**, of the cross-flow type with counterflow, made of plastic resin (PS).
- **Automatic-activation frost protection**, to prevent the formation of frost at the heat exchanger.
- **Thermodynamic or mechanical (BP models), automatic and 100% filtered by-pass**, to guarantee the comfort of the occupants of the rooms in mid-seasons, or whenever the outside temperature does not require the action of the heat exchanger.
- **Remote control unit with LCD display**, of the wired connection type, for:
  - turning the product on and off;
  - the initial configuration of the product;
  - selecting the minimum, average or maximum speed of operation;
  - programming the operation;
  - displaying the time and room temperature;
  - monitoring the correct operation of the product (any malfunctions are highlighted through error messages shown on the display);
  - signaling the saturated filters condition on the display.
- **Pair of M5 filters** (F7 filter available as an option for the delivery duct), easily accessible for periodic maintenance interventions.
- **Condensate collection tray** with drain devices.
- **Possibility of interlocking** with external environmental sensors (optional), for the automatic control of the operating mode.
- **Degree of protection from dust and water**: IPX2.
- **Electrical insulation class**: II (earthing not required).

## TECHNICAL DATA

PRODUCTS	CODE	V~50 HZ	W max	A max	MAX FLOW RATE		MAX PRESSURE		°C* MAX	KG
					m³/h	l/s	mmH <sub>2</sub> O	Pa		
VORT HRI 200 PHANTOM B.P.	11291	230	102	1.0	206	57.2	43.5	426	40	24
VORT HRI 350 PHANTOM B.P.	11293	230	165	1.4	350	97.0	58.0	568	50	33

\* Maximum temperature with continuous operation of the product.





KEY:

- Air extraction
- Air delivery

DETAILS



Condensate drain nozzles.



Side profile, versions with by-pass.



LCD display full version supplied as standard

**VORT PHANTOM RANGE**  
FALSE CEILING HEAT RECOVERY UNIT

**EFFICIENCY CURVES**

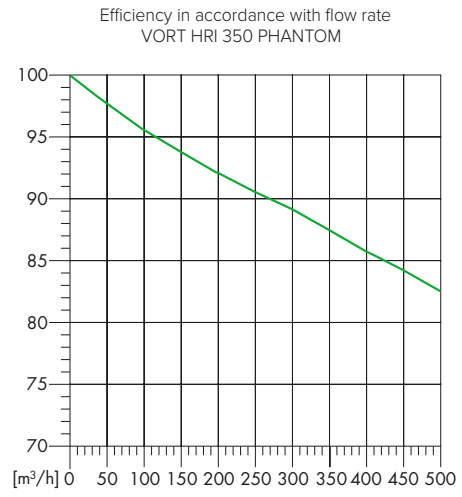
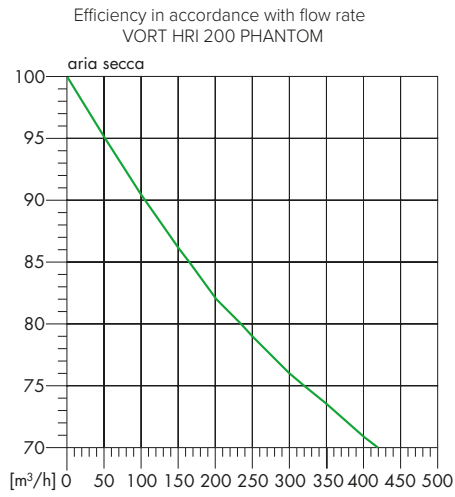

Efficiency in accordance with condensation heat

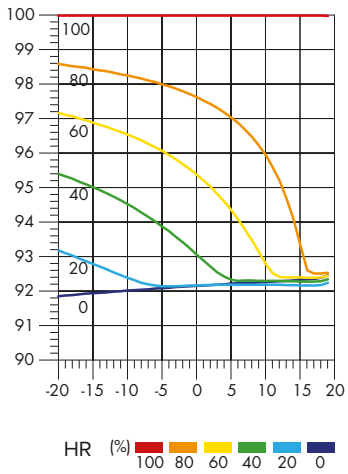

Efficiency in accordance with condensation heat

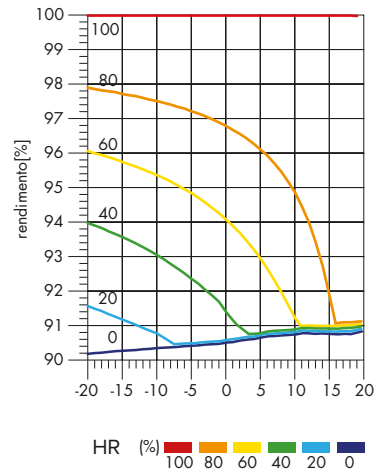









## FILTERS

MODELS	DESCRIPTION	DIMENSIONS	CODE	VORT HRI 200 PHANTOM BP code 11291	VORT HRI 350 PHANTOM BP code 11293
	<b>FILTER F7</b>	228X224X24	22625	✓	
	<b>FILTER F7</b>	230X250X48	22628		✓

## REGULATORS

MODELS	DESCRIPTION	DIMENSIONS	CODE	VORT HRI 200 PHANTOM BP code 11291	VORT HRI 350 PHANTOM BP code 11293
	<b>C TEMP</b> Temperature detector	144x54x55.8	12992	✓	✓
	<b>C SMOKE</b> Polluted air detector	144x54x55.8	12993	✓	✓
	<b>C HCS</b> Humidity detector	144x54x55.8	12994	✓	✓
	<b>C PIR</b> Presence detector	144x54x55.8	12998	✓	✓
	<b>SKP10 INSTALLER PANEL</b> Installer panel	-	22629	✓	✓

## ACCESSORIES

MODELS	DESCRIPTION	CODE	VORT HRI 200 PHANTOM BP code 11291	VORT HRI 350 PHANTOM BP code 11293
	<b>ELECTRIC HEATER 500</b> Pre-heater to prevent the formation of frost in correspondence of the heat exchanger, also in the presence of particularly harsh climates	21630	✓	
	<b>ELECTRIC HEATER 750</b> Pre-heater to prevent the formation of frost in correspondence of the heat exchanger, also in particularly rigid climates	22735		✓
	<b>DCW 250 D.150</b> Cold battery	24146	✓	✓

**VORT PHANTOM RANGE**  
FALSE CEILING HEAT RECOVERY UNIT

**LCD DISPLAY - SUPPLIED AS STANDARD**



TIMER

TEMPERATURE

**SOME ICONS SHOWN ON THE PANEL**

ICONS	FUNCTIONS
	No-Frost
P1 - P2	Time profiles
	Speed
	OFF
	Alarm
	By-pass
	Time schedule programming
FILT	Filter replacement notice
HA	Antibacterial function

Note: For a complete and in-depth explanation of the icons and the associated functions, please refer to the instruction booklet.

The LCD display controls the electronics of the product. Among the various functions, the control panel can be used for:

- turning the machine on and off,
- the initial configuration,
- the manual setting of the operating mode,
- the selection of the 3 speeds,
- the automatic management of the free-cooling function (only models with By-pass),

- setting the time slots and the room temperature,
- the display of the time or outside temperature,
- continuous monitoring of correct operation (any problems are signaled by error messages displayed on the control panel),
- constant monitoring of the filter status (need for maintenance highlighted on the control panel display).



# VORT HRI DH RANGE

HEAT RECOVERY UNITS WITH DEHUMIDIFICATION FUNCTION

**FALSE CEILING CENTRALISED**

**VENTILATION**

**UP TO 240 M<sup>2</sup>**

Centralised dual-flow ventilation units with heat recovery for false ceiling installation, including direct expansion cooling circuit, designed for ventilation and dehumidification of residential and commercial premises with a surface of up to 120 m<sup>2</sup> (VORT HRI DH 260) and 240 m<sup>2</sup> (VORT HRI DH 500) featuring a radiant water cooling system.



- Dual-flow with very high efficiency heat recovery (up to 90%) and integrated dehumidifier, zinc-coated steel sheet casing, exchange pack of the counterflow type made of polyethylene (PE), condensate collection tray, DC EC motors with very low electricity consumption, adjustable speeds, G4 filters on intake and delivery; automatic anti-frost function.
- Total cooling capacity 1400 W/2800 W; useful dehumidification capacity 30 l/24h / 62 l/24h.
- Reciprocating compressor operating with R 134 A gas, double water and air condenser, flow switch, 3-way modulating valve, control electronics with microprocessor including LCD display on the machine controlling the refrigerant circuit, integrated management

of the aeraulic and hydronic sections, summer/winter switching, frost protection, diagnostics of any malfunctions, supervision via RS485 serial port and/or via the Internet (opt.), filter monitoring (opt.).

- False ceiling installation.
- Remote control panel with display (opt.) .
- Can be combined with a dedicated electronic temperature and humidity probe.
- External air intake/stale air expulsion/ return air spigots Ø 125 mm / Ø 160 mm rectangular delivery spigot.
- Automatic motorised recirculation damper.

70

## DIMENSIONS

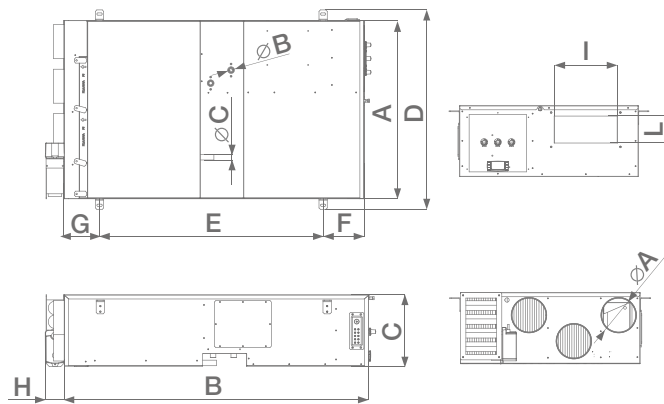

PRODUCTS	CODE	A	B	C	D	E	F	G	H	I	L	ØA	ØB	ØC
VORT HRI 260 DH	45091	655	1103	262	702	821	152	132	65	232	99	125	1/2"	20
VORT HRI 260 DH RC	45092	655	1103	262	702	821	152	132	65	232	99	125	1/2"	20

Dimensions in mm

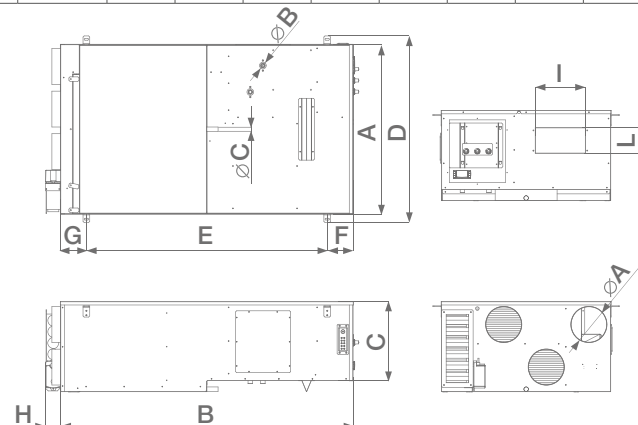

PRODUCTS	CODE	A	B	C	D	E	F	G	H	I	L	ØA	ØB	ØC
VORT HRI 500 DH	45093	756	1304	405	802	1074	116	152	65	224	114	160	1/2"	20
VORT HRI 500 DH RC	45094	756	1304	405	802	1074	116	152	65	224	114	160	1/2"	20

Dimensions in mm



## PERFORMANCE AND ABSORPTION

VORT HRI 260 DH  
DELIVERY FAN

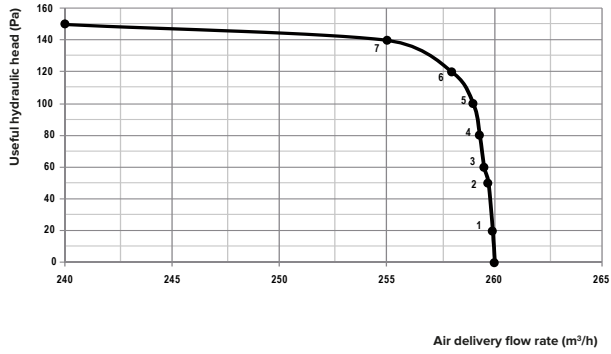

Absorbed power	1	2	3	4	5	6	7
260 M³/H	18 W	30 W	36 W	40 W	46 W	51 W	60 W

VORT HRI 260 DH  
EXPULSION FAN

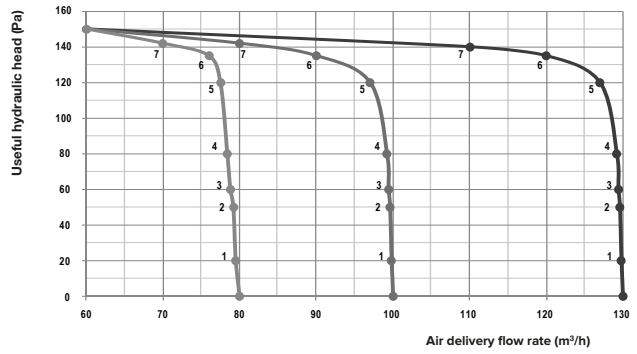

Absorbed power	1	2	3	4	5	6	7
80 M³/H	10 W	11 W	11 W	12 W	12 W	12 W	12 W
100 M³/H	11 W	13 W	15 W	15 W	17 W	18 W	18 W
130 M³/H	11 W	13 W	15 W	19 W	22 W	30 W	34 W

VORT HRI 500 DH  
DELIVERY FAN

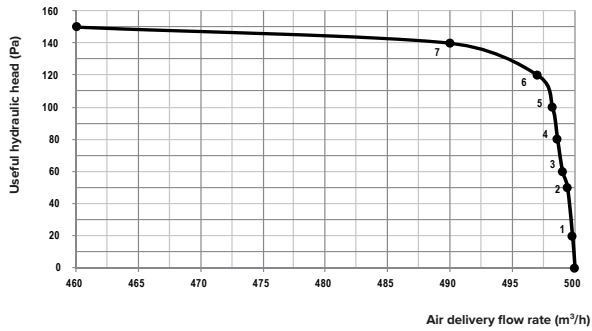

Absorbed power	1	2	3	4	5	6	7
500 m³/h	38 W	60 W	72 W	80 W	92 W	103 W	120 W

VORT HRI 500 DH  
EXPULSION FAN

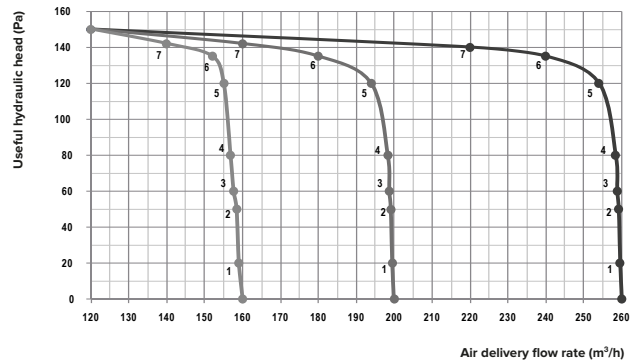

Absorbed power	1	2	3	4	5	6	7
160 m³/h	20 W	22 W	22 W	24 W	24 W	24 W	24 W
200 m³/h	22 W	26 W	30 W	30 W	34 W	36 W	36 W
260 m³/h	22 W	26 W	30 W	38 W	44 W	60 W	68 W

**VORT HRI DH RANGE**  
HEAT RECOVERY UNITS WITH DEHUMIDIFICATION FUNCTION

**PERFORMANCE AND ABSORPTION**

**HYDRAULIC CIRCUIT PRESSURE DROPS**

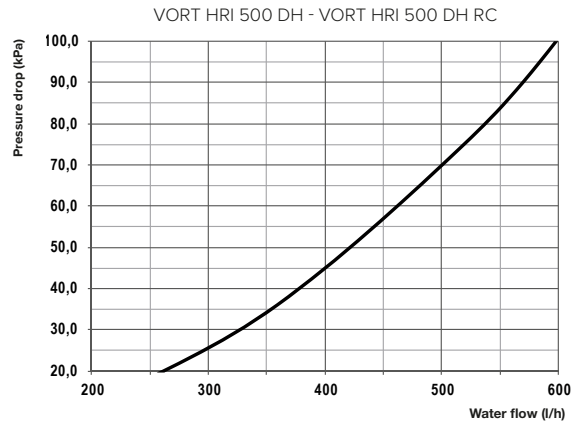
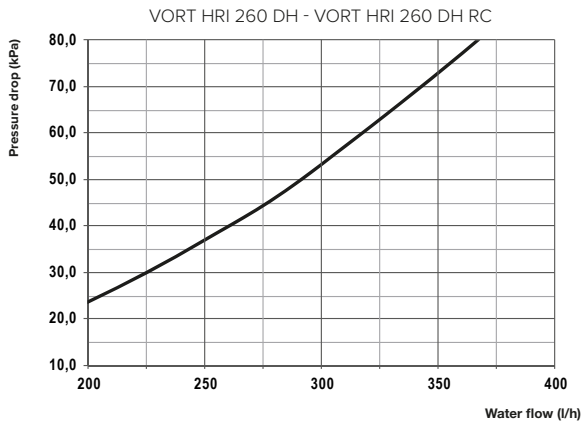

**RECOVERY EFFICIENCY**

Winter: internal conditions 20 °C, 50% RH external air conditions: -5 °C, 80% RH

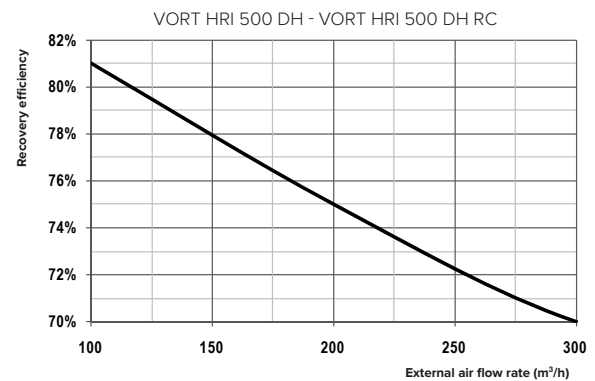
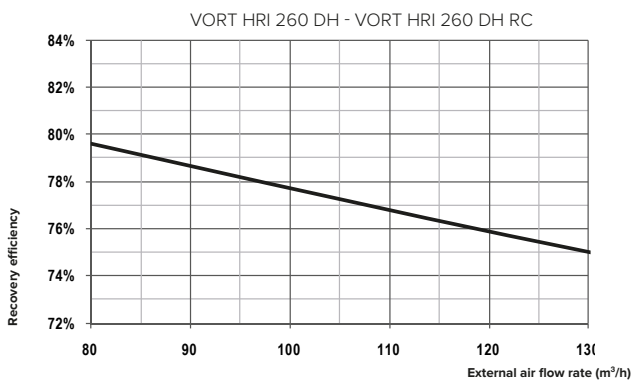
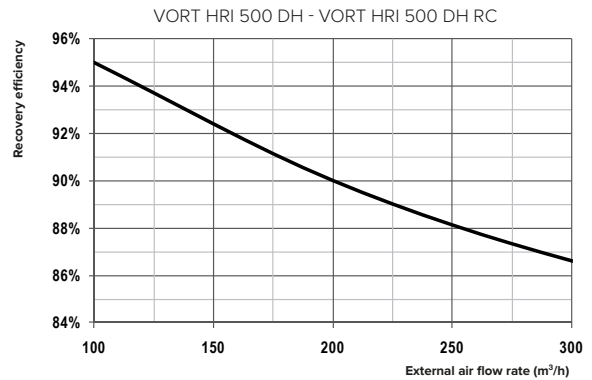
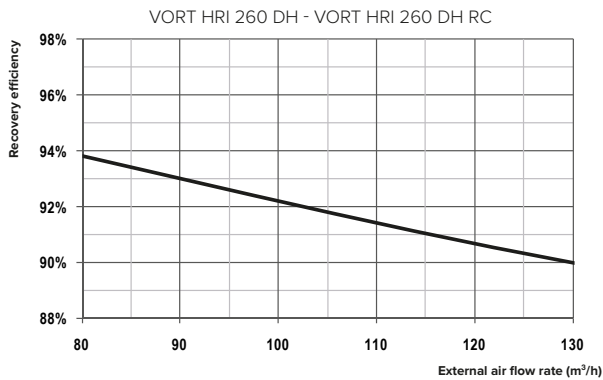

**TECHNICAL DATA**

PRODUCTS	CODE	Nom. Ø (mm)	(m³/h)	(W)	(PA)	Lp [db(A)] 3m
VORT HRI 260 DH	45091	125	130-260	86	150	39
VORT HRI 260 DH RC	45092	125	130-260	86	150	39
VORT HRI 500 DH	45093	160	250-500	150	150	44
VORT HRI 500 DH RC	45094	160	250-500	150	150	44



## MAIN COMPONENTS

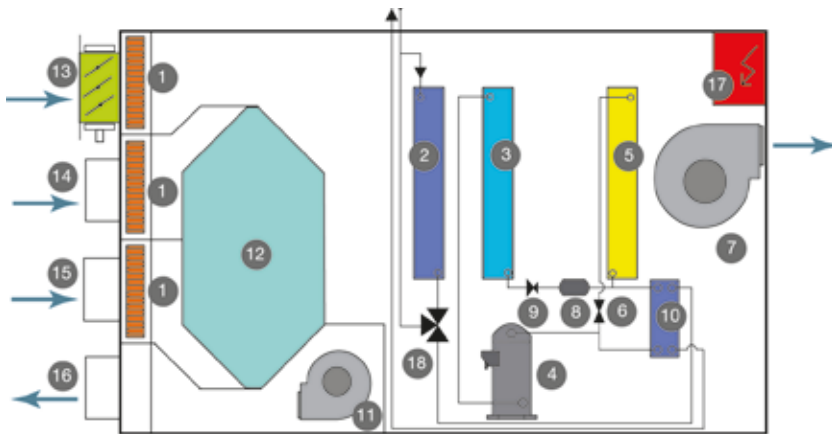

- 1 - Air filter.
- 2 - Pre-cooling (summer function) post-heating (winter function) hydronic battery.
- 3 - Evaporator.
- 4 - Compressor.
- 5 - Air condenser.
- 6 - Solenoid valve.
- 7 - Delivery fan with EC motor.
- 8 - Dehydrator filter.
- 9 - Rolling organ.
- 10 - Water condenser.
- 11 - Exhaust fan with EC.
- 12 - Very-high-efficiency cross-flow recovery system.
- 13 - Motorised return (recirculation) damper.
- 14 - Damp rooms return air.
- 15 - External air.
- 16 - Expelled air.
- 17 - Electrical panel.
- 18 - Three-way modulating valve.

## OPERATING MODE

### SUMMER OPERATION (COMPRESSOR ACTIVE) WITH EXTERNAL AIR

- By setting this function, the unit renews the ambient air with external one through the extremely high-efficiency heat recovery unit.
- The possible functions in this configuration are:
  - Renewal + Dehumidification with neutral air: the unit condenses partially in air and partially in water through the plate condenser, obtaining dehumidified and thermally neutral air.
  - Renewal + Dehumidification with cooling: the unit operates with 100% condensation in water, obtaining dehumidified and cooled air.

### OPERATION IN WINTER AND BETWEEN SEASONS (COMPRESSOR OFF) WITH EXTERNAL AIR

- By setting this function, the unit renews the ambient air with external one through the extremely high-efficiency heat recovery unit.
- Renewal with air heating: The compressor is off, the battery can be supplied with hot water from the radiant system, (even if by virtue of the very high efficiency of the heat recovery unit it is possible to obtain a delivery air temperature of 17 °C, without using hot water, with an outside air temperature of -5 °C), and behaves like a normal thermoventilator with recuperator).

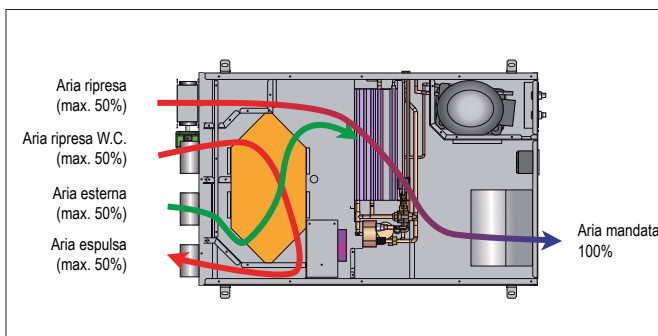

Please note: In summer mode the appliance cannot operate without the aid of cold and/or hot water. In the event of low or no water flow, the unit is turned off and the safety devices are activated.

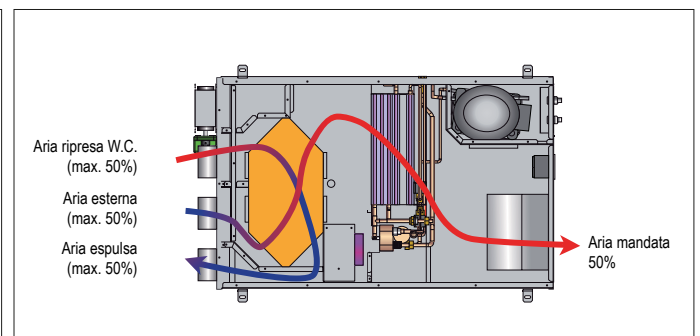

Please note: In winter mode the appliance has the compressor off and operates as a thermo fan with very-high-efficiency heat recovery.

## TECHNICAL FEATURES

---

- **4 models**, different in size, performance, equipment, and offered features.
- **Casing made of zinc-coated steel sheet** with removable panels for direct access to internal filters. VORT HRI 260 DH models have the lower cover made of thermoformed plastic resin. Tie-rods for suspended installation supplied as standard.
- **Intake and delivery spigots** compatible with pipes with 125 mm (VORT HRI 260 DH) and 160 mm (VORT HRI 500 DH) nominal diameter.
- **Pair of centrifugal fans driven by EC (brushless) motors** of the external rotor type, with shafts mounted on ball bearings, directly coupled to centrifugal impellers. 2 operating speeds, independently settable upon installation.
- **High-efficiency heat exchanger**, of the cross-flow type with counterflow, made of plastic resin (PS).
- **Automatic-activation frost protection**, to prevent the formation of frost at the heat exchanger.
- **Motorised circulation damper**.
- **Ready for the connection** to mechanical (RC versions) or electronic (DH versions) hygrometers (optional).
- **Compressor running on gas type HFC R134a**.
- **3-way modulating valve**.
- **Double condenser** (water + air).
- Flow switch.
- Control electronics with microprocessor, including **LCD display**.
- **Pair of G4 filters**, easily accessible for periodic maintenance interventions.
- **Condensate collection tray** with drain devices.
- **Three operating modes:**
  - SUMMER: ventilation with heat recovery (neutral air) and dehumidification;
  - SUMMER + COOLING: ventilation with heat recovery (cooled air) and dehumidification;
  - WINTER: ventilation with heat recovery.
- **Degree of protection from dust and water:** IPX2.
- **Electrical insulation class:** I (earthing required).



## TECHNICAL DATA

PRODUCTS	VORT HR 260 DH CODE 45091	VORT HR 260 DH RC CODE 45092	VORT HR 500 DH CODE 45093	VORT HR 500 DH RC CODE 45094
POWER SUPPLY	230 V / 50 Hz	230 V / 50 HZ	230 V / 50 HZ	230 V / 50 HZ
DELIVERY FAN ABSORBED POWER (MIN/NOM/MAX) (W)	10-30-86	10-30-86	30-60-130	30-60-130
RECOVERY FAN ABSORBED POWER (MIN/NOM/MAX) (W)	11-22-43	11-22-43	22-44-68	22-44-68
TOTAL FRIDGE POWER IN THE ENVIRONMENT (W)	1380	1380	2820	2820
COMPRESSOR ABSORBED NOMINAL POWER (W)	340	340	480	480
WINTER THERMAL POWER RECOVERED (W)	950	950	1850	1850
TYPE OF REFRIGERANT	R134A	R134A	R134A	R134A
USEFUL DEHUMIDIFICATION CAPACITY (L/24H)	30.1	30.1	61.8	61.8
NOMINAL EFFICIENCY RECOVERED IN SUMMER (%)	70	70	70	70
NOMINAL EFFICIENCY RECOVERED IN WINTER (%)	90	90	90	90
HYDRAULIC CIRCUIT PRESSURE DROPS (NOM) (KPA)	38	38	35	35
BATTERY WATER FLOW RATE (MIN/NOM/MAX) (L/H)	150-250-400	150-250-400	200-350-600	200-350-600
DELIVERY AIR FLOW RATE IN SUMMER (M3/H)	260	260	500	500
DELIVERY AIR FLOW RATE IN WINTER (M3/H)	0-130	0-130	0-250	0-250
NOISE LEVEL LW DB (A)	47	47	52	52
ACOUSTIC PRESSURE LP DB(A) 3 M	39	39	44	44
USEFUL DELIVERY FAN HYDRAULIC HEAD (NOM/MAX) (PA)	50-140	50-140	50-140	50-140
USEFUL RECOVERY FAN HYDRAULIC HEAD (NOM/MAX) (PA)	50-140	50-140	50-140	50-140
KG	60	60	80	80

**VORT HRI DH RANGE**  
HEAT RECOVERY UNITS WITH DEHUMIDIFICATION FUNCTION

**DETAILS**



Predisposition for combination with mechanical (RC versions) or electronic (DH versions) hygrostats (optional).



Adapter available for circular duct passage:  
R2T 260 - R2T 500



Control electronics with microprocessor, including LCD display.

Back of the product.



CONTROL PANEL supplied as standard. (see operation details below).

**CONTROL DISPLAY - SUPPLIED AS STANDARD**

Summer mode button

Winter mode button

SET button (set-point display, access to menus, confirmation of parameter value during modification)

UP button (Navigation menu, parameter scrolling, parameter value scrolling)



DOWN button (Menu navigation, parameter scrolling, parameter value scrolling)

MENU BUTTON (access to menu navigation)

Note: For a complete and in-depth explanation of the icons and the associated functions, please refer to the instruction booklet.



## REGULATORS

MODELS	DESCRIPTION	CODE	VORT HR 260 DH CODE 45091	VORT HR 260 DH RC CODE 45092	VORT HR 500 DH CODE 45093	VORT HR 500 DH RC COD. 45094
	<b>RCP (HRI DH)</b> Remote control panel	22607	✓	✓	✓	✓
	<b>ETRH (HRI DH)</b> Electronic probe for humidity and temperature detection.	22608	✓		✓	
	<b>MTRH (HRI DH)</b> Remote mechanical thermohygrostat.	22609		✓		✓

System components (description and data from page. ...)

Regulators (description and data from page. ...).

## ACCESSORIES

MODELS	DESCRIPTION	CODE	VORT HR 260 DH CODE 45091	VORT HR 260 DH RC COD. 45092	VORT HR 500 DH CODE 45093	VORT HR 500 DH RC COD. 45094
	<b>R2T 260 (HRI DH)</b> Conveyor	22656	✓	✓		
	<b>R2T 500 (HRI DH)</b> Conveyor	22657			✓	✓

# COMPONENTS

---

## A SMART SYSTEM IS AN EFFECTIVE SYSTEM

---



78

The distribution plenums are a very important part of the distribution system, regulating the air flow of the individual lines. The air volumes of the individual ducts are managed through the flow regulators connected directly to the distribution plenum.



---

### SYSTEMS

<b>WDG75</b>	Ø 75	plastic
<b>WDG63</b>	Ø 63	plastic
<b>WDG35</b>	Ø 35	plastic

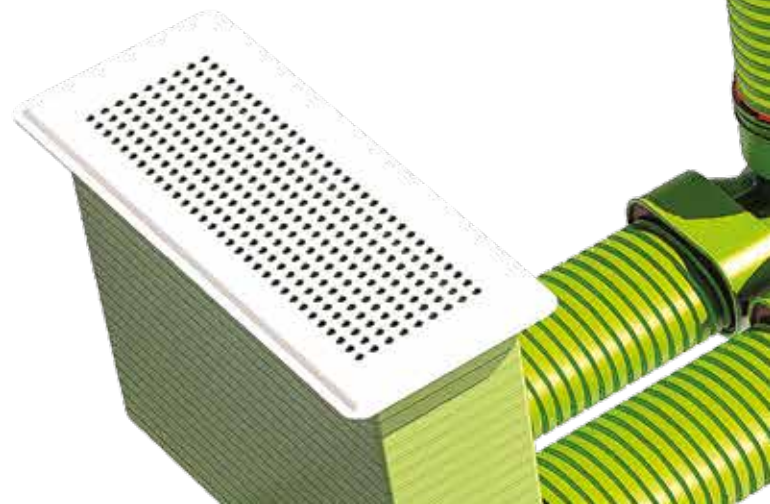

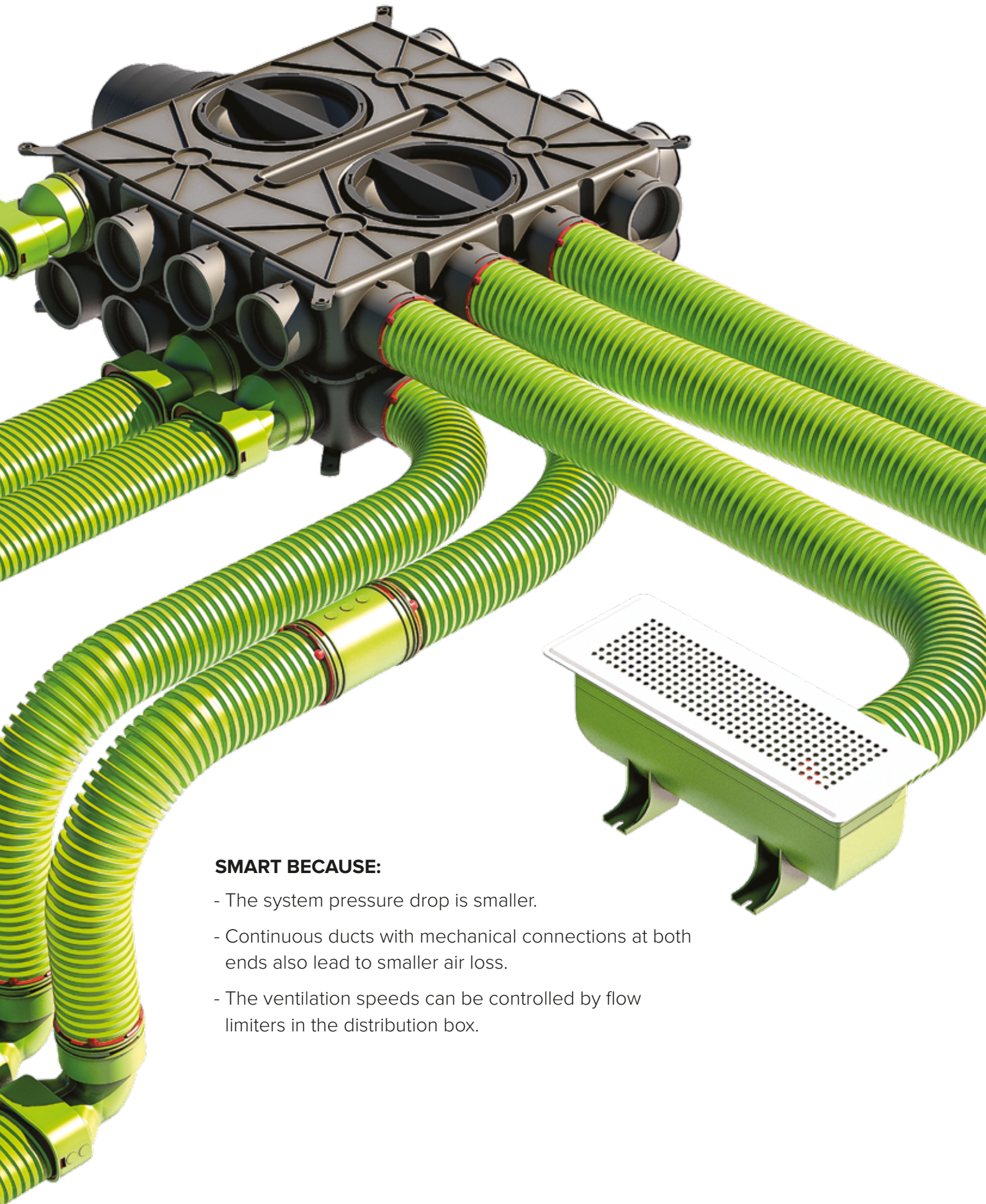

**SMART BECAUSE:**

- The system pressure drop is smaller.
- Continuous ducts with mechanical connections at both ends also lead to smaller air loss.
- The ventilation speeds can be controlled by flow limiters in the distribution box.

# SYSTEM WDG63 - WDG75 - WDG35

## DISTRIBUTION PLENUM

### CENTRALISED VENTILATION

The PE distribution plenum of the **WDG-PH PLUS-C** system is compact and light; it comes with **6** standard connections. Ideal for residential applications of limited volume or in case of small installation spaces.



- Air flow adjustable using 12-level static flow regulators (code 25074), easy to clean and easy reassembly of the flow regulators (maintenance).
- Made of exclusively virgin PP granulate.
- With 125-mm adapter for flow duct (code 25074).
- Including adjustment diaphragms and 3 caps.

### DIMENSIONS

80

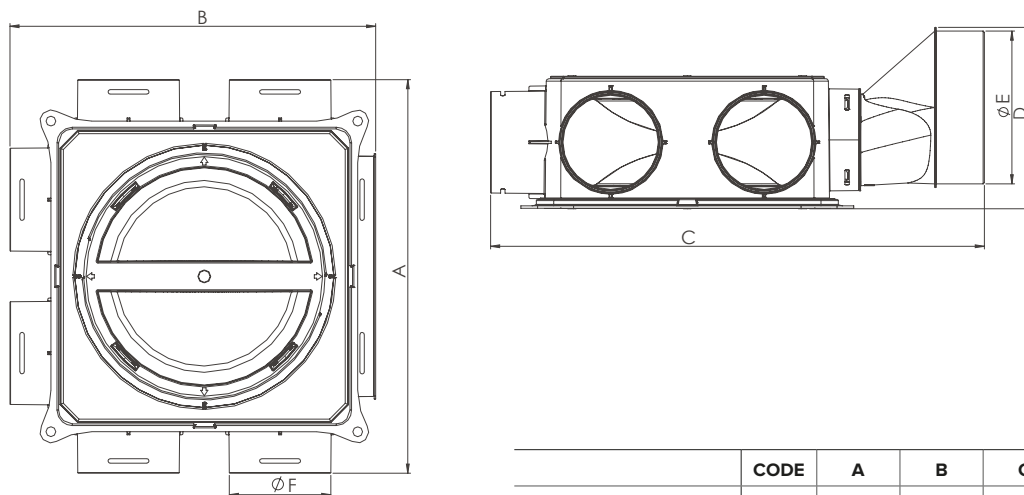

	CODE	A	B	C	D	ØE	ØF
WDG-PH PLUS-C 6X63	21323	318	299	399	148	125	85

Dimensions in mm

### TECHNICAL DATA

Box configuration	with 125-mm adapter for flow duct
Qv (Volume) [m3/h]	Pressure drop (Pa)
50	2.0
75	3.0
100	4.0
125	5.0
150	8.0
175	10.0
200	12.0
225	14.0
250	-
300	-
350	-



## CENTRALISED VENTILATION

The distribution plenum in PE of the **WDG-PH PLUS-C** system range is compact and light; it comes with **8 connections**. The distribution plenum is ideal for residential applications of limited volume or in case of small installation spaces.



- Air flow adjustable using 12-level static flow regulators (code 25074).
- Easy to clean and easy reassembly of the flow regulators (maintenance).
- Made of exclusively virgin PP granulate.
- Including adjustment diaphragms and 4 caps.

## DIMENSIONS

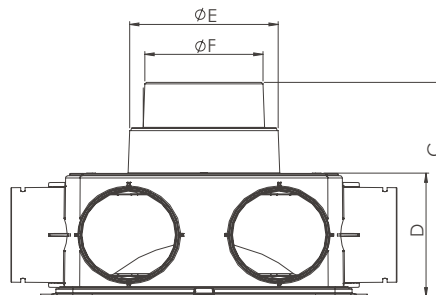
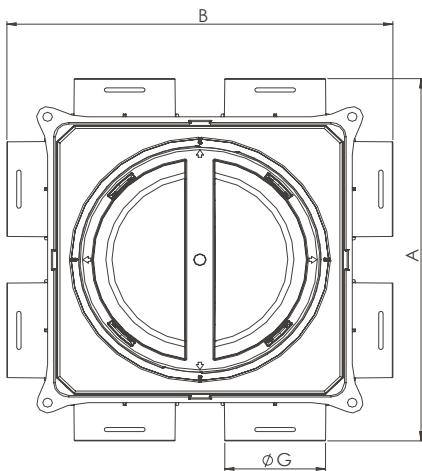

	CODE	A	B	C	D	ØE	ØF	ØG
WDG-PH PLUS-C 8X63	21324	318	318	188	109	125	100	85

Dimensions in mm

## TECHNICAL DATA

Box configuration	1		2	
	Pressure drop (Pa)			
Qv (Volume) [m <sup>3</sup> /h]				
50	1.0		1.0	
75	1.5		1.5	
100	2.0		2.0	
125	3.0		3.0	
150	5.0		5.0	
175	6.5		6.5	
200	8.0		8.0	
225	9.0		9.0	
250	10.0		-	
300	-		-	
350	-		-	

- 1 with adapter for multi-diameter flow duct 125-180 mm
- 2 with adapter for multi-diameter flow duct 100-125 mm

# SYSTEM WDG63 - WDG75 - WDG35

## DISTRIBUTION PLENUM

### CENTRALISED VENTILATION

**WDG-P PLUS** is a duct system specifically designed for controlled mechanical ventilation of rooms with or without heat recovery, for homes or small commercial areas. The ventilation unit is connected to the distribution plenums by means of insulated ducts and silencers, the air is distributed through the semi-rigid ducts to supply fresh air to the habitable rooms and extract the exhausted one from the damp rooms.



- Distribution plenum with **8 connections** for WDG system
- Including adjustment diaphragms and 4 caps.
- Made of exclusively virgin PP granulate.

### DIMENSIONS

82

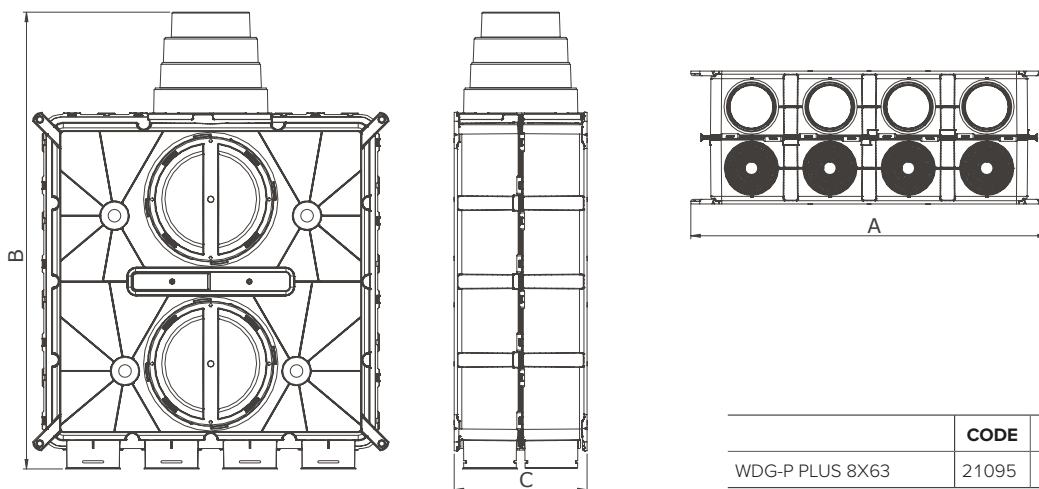

	CODE	A	B	C
WDG-P PLUS 8X63	21095	565	722	210

Dimensions in mm

### TECHNICAL DATA

#### Pressure drop

Qv (Volume) [m3/h]	Pressure drop (Pa)
100	1.0
150	1.7
200	2.7
250	4.0
300	5.7
350	7.6
400	9.9
450	12.4

**WDG-P PLUS** is a duct system specifically designed for controlled mechanical ventilation of rooms with or without heat recovery, for homes or small commercial areas. The ventilation unit is connected to the distribution plenums by means of insulated ducts and silencers, the air is distributed through the semi-rigid ducts to supply fresh air to the habitable rooms and extract the exhausted one from the damp rooms.



- Distribution plenum connection  $\varnothing$  125-150-160-180 mm.
- **16 connections** for WDG system.
- Including adjustment diaphragms and 8 caps.

## DIMENSIONS

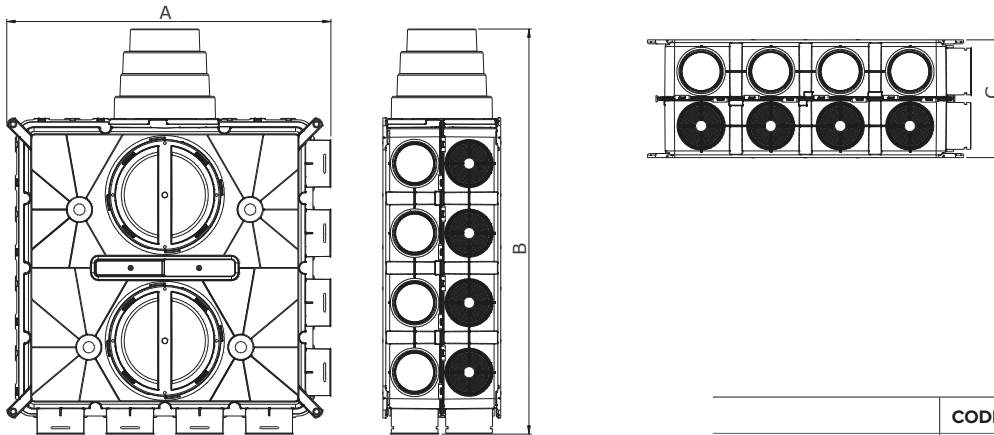

	CODE	A	B	C
WDG-P PLUS 16X63	21096	578	722	210

*Dimensions in mm*

## TECHNICAL DATA

### Pressure drop

Qv (Volume) [m <sup>3</sup> /h]	Pressure drop (Pa)
100	1.0
150	1.7
200	2.7
250	4.0
300	5.7
350	7.6
400	9.9
450	12.4

# WDG63 - WDG75 SYSTEM

CIRCULAR

## ACCESSORIES

The **flow regulator** makes it possible to set the air flow determined for each duct. It is directly connected to the distribution plenum, and using adapters it can be connected to any type of duct. The setting can be defined by aeraulic calculations. The air flow can be easily adjusted thanks to the lever without the need to intervene on the system.



- It enables the precise setting of the air flow between the distribution plenums and the various rooms.
- Easy flow rate adjustment in case of system changes.
- Quick and easy installation.
- Installable on distribution plenums, compatible with the whole range of ducts through the use of adapters.
- Made of exclusively virgin PP granulate.

## DIMENSIONS

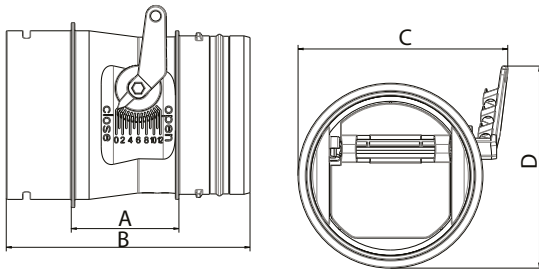

	CODE	A	B	C	D
WDG-RRM	25074	53	120	103	99

Dimensions in mm

## TECHNICAL DATA

Qv (Volume) [m <sup>3</sup> /h]	V (Speed) [m <sup>3</sup> /h]	Pressure drop (Pa)													
		Pos. 0	Pos. 1	Pos. 2	Pos. 3	Pos. 4	Pos. 5	Pos. 6	Pos. 7	Pos. 8	Pos. 9	Pos. 10	Pos. 11	Pos. 12	
5.6	0.5	38.8	28.6	11.0	1.0	0.0	0.0	0.0	0.0	0.0	0.0	0.0	0.1	0.1	
11.2	1.0	89.1	70.9	35.6	12.0	0.4	0.0	0.0	0.0	0.2	0.1	0.3	0.4	0.3	
16.8	1.5	150.8	127.0	73.8	33.1	10.9	0.4	0.0	0.0	1.6	0.9	0.8	0.9	0.7	
22.4	2.0	218.4	193.3	124.0	64.9	30.3	13.9	5.8	6.2	5.2	3.1	1.8	0.9	0.5	
28.1	2.5	307.0	279.5	190.5	105.8	53.8	26.0	11.5	9.5	8.1	4.8	3.0	2.0	1.5	
33.7	3.0	405.8	378.4	270.4	156.8	84.3	42.6	20.1	14.4	11.9	7.1	4.4	3.2	2.5	
39.3	3.5	514.9	490.0	363.6	217.9	121.8	63.7	31.7	20.9	16.7	9.9	6.2	4.6	3.7	
44.9	4.0	634.3	614.3	470.2	289.2	166.3	89.5	46.1	29.0	22.5	13.3	8.2	6.2	5.0	
50.5	4.5	764.0	751.2	590.2	370.5	217.8	119.7	63.5	38.6	29.2	17.3	10.6	7.9	6.4	
56.1	5.0	904.0	900.8	723.5	462.1	276.3	154.6	83.7	49.9	36.8	21.9	13.2	9.8	8.0	
61.7	5.5	-	-	870.2	563.7	341.8	193.9	106.9	62.7	45.4	27.0	16.2	11.9	9.7	
67.3	6.0	-	-	1030.3	675.5	414.2	237.9	132.9	77.1	54.9	32.7	19.5	14.1	11.5	
72.9	6.5	-	-	-	797.3	493.6	286.4	161.9	93.1	65.5	38.9	23.1	16.5	13.4	
78.6	7.0	-	-	-	929.4	580.0	339.4	193.7	110.7	76.8	45.7	26.9	19.0	15.5	
84.2	7.5	-	-	-	-	673.4	397.1	228.5	129.9	89.1	53.1	31.1	21.8	17.7	
89.8	8.0	-	-	-	-	773.8	459.2	266.1	150.6	102.4	61.1	35.6	24.6	20.0	
95.5	8.5	-	-	-	-	881.2	526.0	306.7	172.0	116.7	69.6	40.4	27.7	22.4	
101.0	9.0	-	-	-	-	-	597.3	350.1	196.9	131.8	78.6	45.5	30.9	25.0	
106.6	9.5	-	-	-	-	-	673.1	396.5	222.4	148.0	88.3	50.9	34.3	27.7	
112.2	10.0	-	-	-	-	-	753.5	445.7	249.5	165.1	98.5	56.6	37.8	30.6	

## DUCTS

Double-walled semi-flexible internally smooth corrugated duct made of HDPE (high density polyethylene). Self-extinguishing external and antistatic internal treatment. It can be used for a floor distribution system (walkable).



- Quick and easy to install.
- Corrugated external surface to protect against any installation damage.
- Smooth internal surface to minimise pressure drops and ensure long-term cleaning.
- Antistatic and antibacterial properties.
- Suitable for new and renovated buildings.
- Made of exclusively virgin PE granulate.

## DIMENSIONS

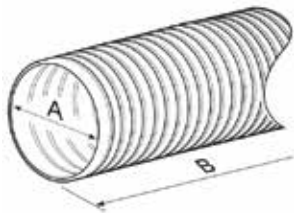

	CODE	ØA	B
WD 63	23209	63	50000
WD 75	21325	75	50000

Dimensions in mm

## TECHNICAL DATA



WD63

WD63



WD75

WD75

Radius [mm]	0		150	
Duct route	1		1	
Qv (Volume) [m³/h]	v [m/s]	(Pa)	v [m/s]	(Pa)
0	0.0	0.0	0.0	0.0
5	0.4	0.0	0.4	0.1
10	0.9	0.2	0.9	0.4
15	1.3	0.6	1.3	0.9
20	1.8	1.2	1.8	1.7
25	2.2	2.0	2.2	2.6
30	2.7	2.9	2.7	3.8
35	3.1	4.1	3.1	5.2
40	3.6	5.4	3.6	6.7
45	4.0	7.0	4.0	8.5
50	4.5	8.7	4.5	10.5
55	4.9	10.6	4.9	12.8
60	5.3	12.7	5.3	15.2

Radius [mm]	0		150	
Duct route	1		1	
Qv [m³/h]	v [m/s]	(Pa)	v [m/s]	(Pa)
0	0.0	0.0	0.0	0.0
5	0.3	0.0	0.3	0.1
10	0.6	0.1	0.6	0.1
15	0.9	0.2	0.9	0.3
20	1.3	0.4	1.3	0.5
25	1.6	0.6	1.6	0.9
30	1.9	0.9	1.9	1.2
35	2.2	1.3	2.2	1.7
40	2.5	1.7	2.5	2.2
45	2.8	2.2	2.8	2.8
50	3.1	2.7	3.1	3.4
55	3.5	3.3	3.5	4.2
60	3.8	3.9	3.8	4.9
65	4.1	4.6	4.1	5.8
70	4.4	5.4	4.4	6.7
75	4.7	6.2	4.7	7.7
80	5.0	7.1	6.0	8.8

# WDG63 - WDG75 SYSTEM

## CIRCULAR

### DUCTS

Circular reduction from WDG63 to WDG75 system.



	CODE
WDG - R 63-75	21355

Straight connector for WDG63 and WDG75 systems.



	CODE
WDG-J 63	21085
WDG-J 75	21354

Cap for WDG63 system



	CODE
WDG-X 63	21087

Anti-slip ring for WDG63 and WDG75 system (10 pieces).



	CODE
WDG-RR 63	21088
WDG-RR 75	21329

Flexible aluminum pipe with circular section glass wool insulation.

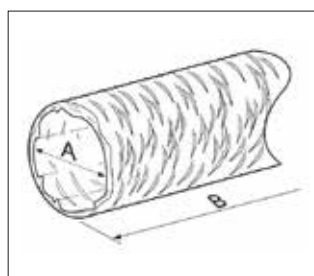

	CODE	ØA	B
INSULATED AL. PIPE Ø 127	46272	127	10M
INSULATED AL. PIPE Ø 154	46428	154	10M

Silencer pipe.

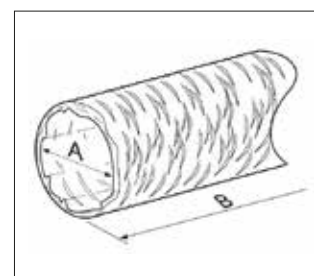

	CODE	ØA	B
SILENCER PIPE Ø 125	22366	127	5M
SILENCER PIPE Ø 150	22316	154	5M

## DUCTS

Sealing ring **(10 pieces)** for WDG63 and WDG75 systems.



	CODE
WDG-OR 63	21086
WDG-OR 75	21328

### TIP

#### Flow duct adapter for WDG-PH PLUS-C plenum

The flow duct can be connected vertically by means of the 125/150/160/180-mm multi-diameter adapter or a 100/125-mm adapter.



	CODE
WDG - CO	21356



Positioning of the sealing ring (black) and anti-slip ring (red)



# WDG63 - WDG75 SYSTEM

CIRCULAR

## DIFFUSION TERMINALS

The valve adapter has been developed for ceiling or wall installations. It has been designed to cross most of structures such as walls, screeds, or false ceilings. The adapter can be cut to size with common equipment and then assembled with the termination of the ventilation system: the air delivery or extraction valve.



- For air delivery and extraction.
- For ceiling or wall installations.
- Easy to cut to the desired size.
- Antistatic and antibacterial properties.
- Made of exclusively virgin PP granulate.

## DIMENSIONS

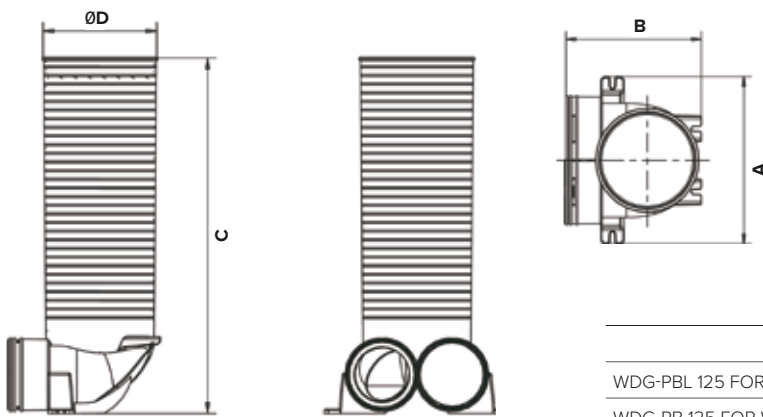

	CODE	A	B	C	ØD
WDG-PBL 125 FOR WDG 75	21326	215	125	173	190
WDG-PB 125 FOR WDG 63	21090	215	175	412	125

Dimensions in mm

## TECHNICAL DATA

Duct route	Air delivery				Air extraction			
	1		2		1		2	
Qv (Volume) [m³/h]	v [m/s]	(Pa)	v [m/s]	(Pa)	v [m/s]	(Pa)	v [m/s]	(Pa)
0	0.0	0.0	0.0	0.0	0.0	0.0	0.0	0.0
5	0.7	0.3	0.3	0.0	0.7	0.2	0.3	0.1
10	1.3	1.0	0.7	0.2	1.3	0.9	0.7	0.2
15	2.0	2.3	1.0	0.4	2.0	2.1	1.0	0.5
20	2.6	4.1	1.3	0.7	2.6	3.7	1.3	1.0
25	3.3	6.4	1.6	1.2	3.3	5.7	1.6	1.5
30	3.9	9.2	2.0	1.7	3.9	8.3	2.0	2.2
35	4.6	12.5	2.3	2.3	4.6	11.3	2.3	2.9



## DIFFUSION TERMINALS

The grille adapter has been originally developed only for the introduction of air and for floor or wall installations. It can be cut in length with common equipment. It comes with a dust cap on the outlet and a removable cap on one of the two connections for circular duct.



- For air delivery.
- For wall or floor installations.
- Easy to cut to the desired size.
- Antistatic and antibacterial properties.
- Made of exclusively virgin PP granulate.

## DIMENSIONS

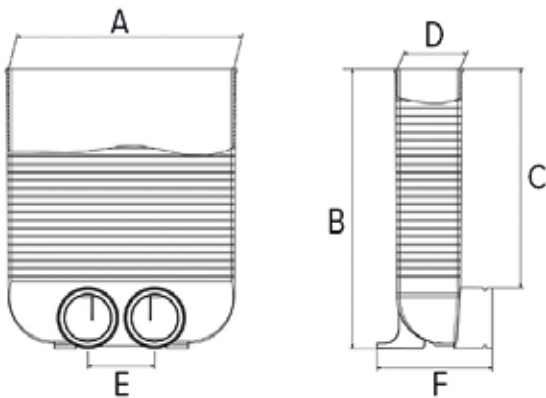

	CODE	A	B	C	D	E	F
WDG-PB 310X85	21093	309	384	300	86	92	159

*Dimensions in mm*

## TECHNICAL DATA

### Air delivery with grille

Duct route	1		2		
	Qv (Volume) [m <sup>3</sup> /h]	v [m/s]	(Pa)	v [m/s]	(Pa)
0	0.0	0.0	0.0	0.0	0.0
5	0.4	0.1	0.2	0.1	0.1
10	0.9	0.5	0.4	0.3	0.3
15	1.3	1.2	0.7	0.7	0.7
20	1.8	2.1	0.9	1.2	1.2
25	2.2	3.3	1.1	1.8	1.8
30	2.7	4.8	1.3	2.6	2.6
35	3.0	6.0	1.6	3.5	3.5
40	3.1	6.5	1.8	4.6	4.6
45	3.6	8.5	2.0	5.9	5.9
50	4.0	10.7	2.2	7.2	7.2
55	4.5	13.2	2.5	8.8	8.8

### Air delivery with grille

Duct route	1		2		
	Qv (Volume) [m <sup>3</sup> /h]	v [m/s]	(Pa)	v [m/s]	(Pa)
60	4.9	16.0	2.7	10.4	10.4
65	5.3	19.1	2.9	12.2	12.2
67	-	-	3.0	13.1	13.1
70	-	-	3.1	14.2	14.2
75	-	-	3.3	16.3	16.3
80	-	-	3.6	18.5	18.5
85	-	-	3.8	20.9	20.9
90	-	-	4.0	23.5	23.5
95	-	-	4.2	26.1	26.1
100	-	-	4.5	28.9	28.9
105	-	-	4.7	31.9	31.9
110	-	-	4.9	35.0	35.0
115	-	-	5.1	38.3	38.3

# WDG63 - WDG75 SYSTEM

CIRCULAR

## DIFFUSION TERMINALS

Delivery/recovery spigot with adjustable flow. White polystyrene casing, manual opening/closing/adjustment system.



	CODE	ØA	B
BOREA 125	23199	125	165

Dimensions in mm

**Example of Borea 125 terminal installation with WDG Plenum.**



**Example of perforated terminal installation with WDG rectangular Plenum.**



High induction spigot 300x100, with perforated front made of white powder-coated zinc-coated steel. Suitable for delivery and extraction.

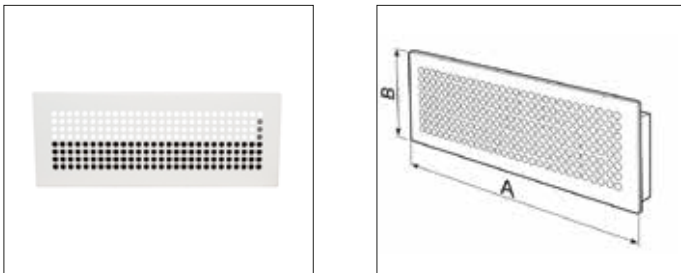

	CODE	A	B
WDG-BF 310X85	21094	310	85

Dimensions in mm

Extraction/delivery spigot made of white thermoplastic polystyrene. Enables air flow regulation with a simple adjustment of the rotating core. To be applied to ceilings, ventilation ducts, false ceilings, etc.

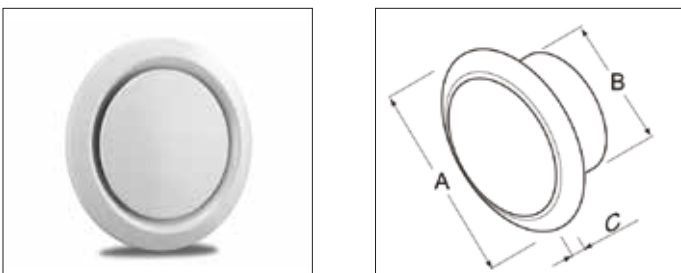

	CODE	ØA	ØB	C
AV 125	22190	166	125	15

Dimensions in mm

## DIFFUSION TERMINALS

Steel extraction/delivery spigots. They enable the regulation of the air flow with a simple adjustment of the rotating core. To be applied to ceilings, ventilation ducts, false ceilings, etc. To be combined with an aesthetic mask (circular, square and rectangular). Revolutionary sound data that guarantee excellent noise levels.

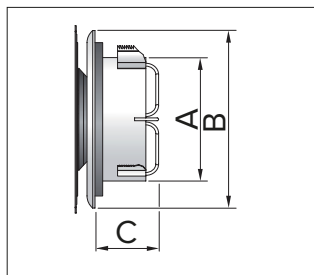

	CODE	ØA	ØB	C
AV PLUS BD 125	26794	114	156	57

Dimensions in mm

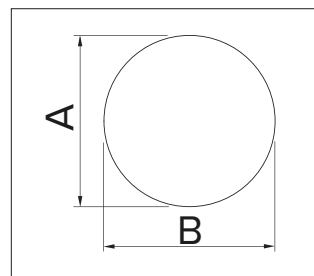
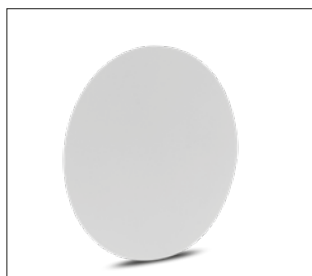

	CODE	ØA	ØB
AV PLUS RND (CIRCULAR)	26797	165	165

Dimensions in mm

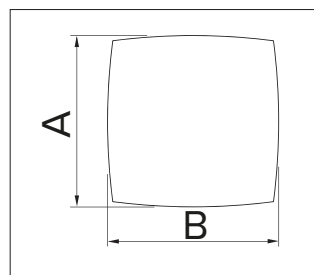
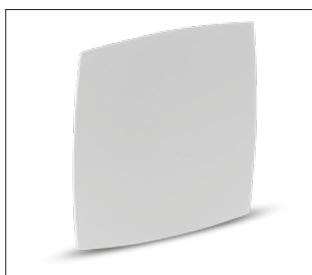

	CODE	A	B
AV PLUS BOW (SQUARE)	26795	165	165

Dimensions in mm

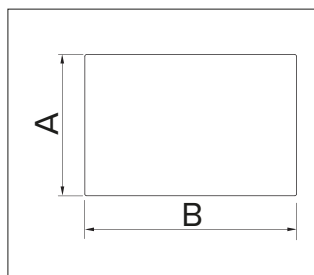
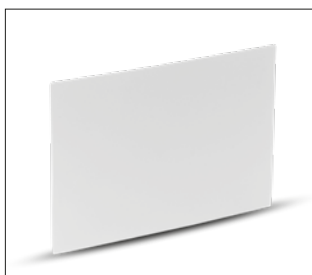

	CODE	A	B
AV PLUS RCT (RECTANGULAR)	26796	165	248

Dimensions in mm

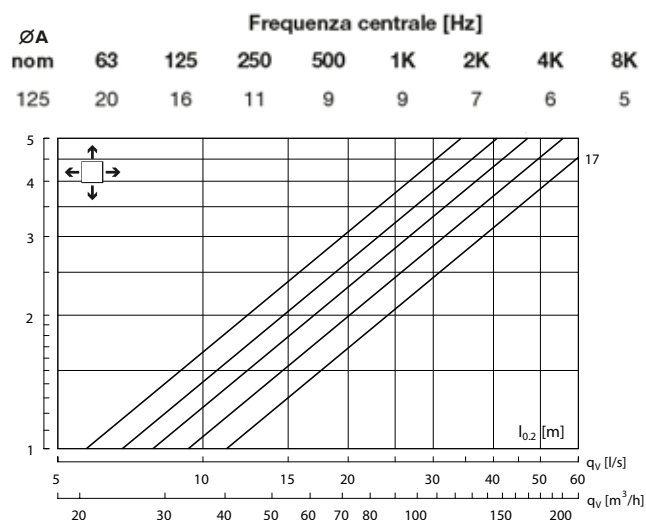

### Delivery curve

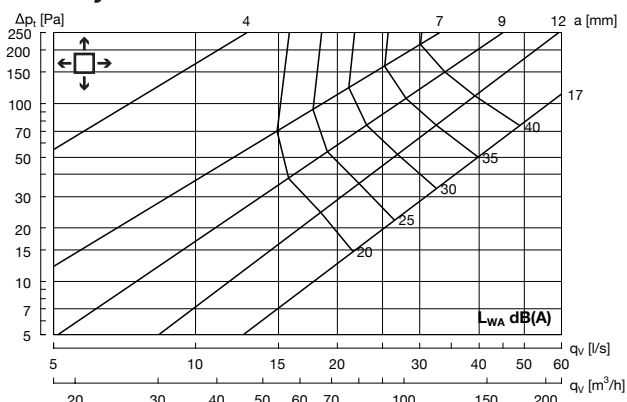

Hz	63	125	250	500	1K	2K	4K	8K
K <sub>ak</sub>	4	-6	-1	0	-6	-11	-15	-15

### Recovery curve

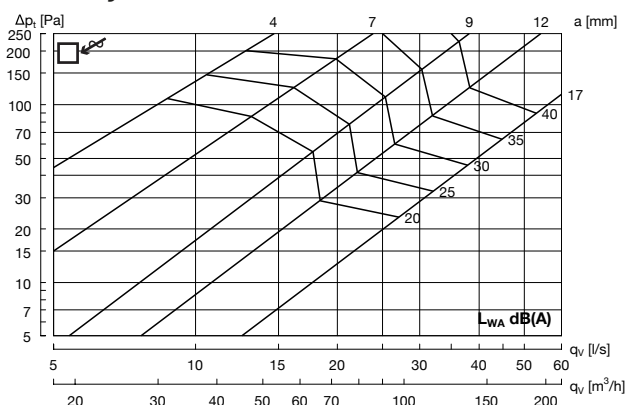

Hz	63	125	250	500	1K	2K	4K	8K
K <sub>ak</sub>	8	-9	-3	-3	-5	-6	-17	-21

# WDG63 - WDG75 SYSTEM

CIRCULAR

## DIFFUSION TERMINALS

Rectangular spigot plenum, multiple connection made of PE, size 170x120. Includes connection for WDG63 (75 mm) or WDG75 (90 mm). Brackets for wall or plasterboard fixing included. Filter included. Possibility to connect several spigot plenums in series and to choose the position of the joint.



	CODE
WDPE-PB 170X120	26798

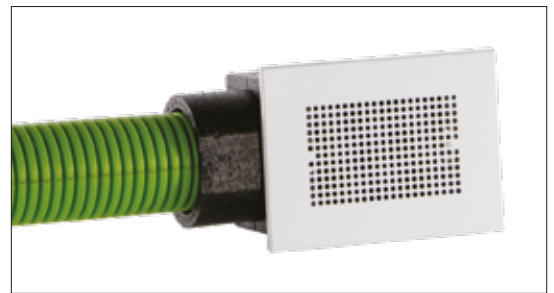

High-induction spigot, with perforated front made of white powder-coated zinc-coated steel. Suitable for delivery and extraction.

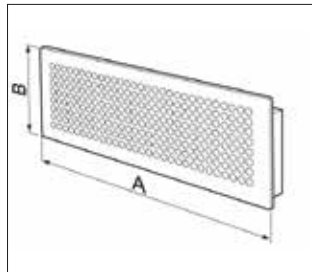
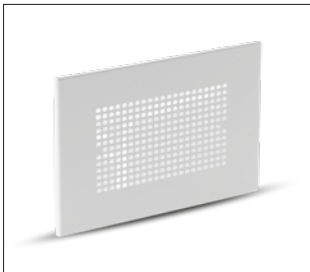

	CODE	A	B
WDPE-BF 193X140	26799	193	140

Dimensions in mm

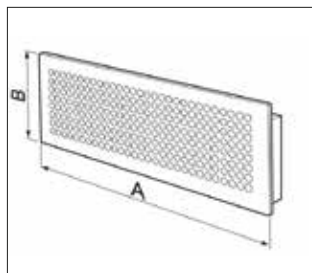
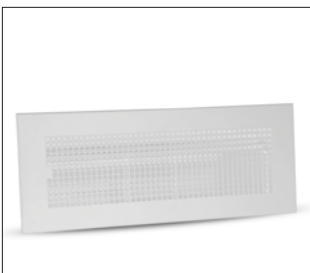

	CODE	A	B
WDPE-BF 366X140	25073	366	140

Dimensions in mm

## WALL PLENUM

Rectangular spigot plenum, multiple connection made of ABS. Includes double connection for WD63 (75 mm).

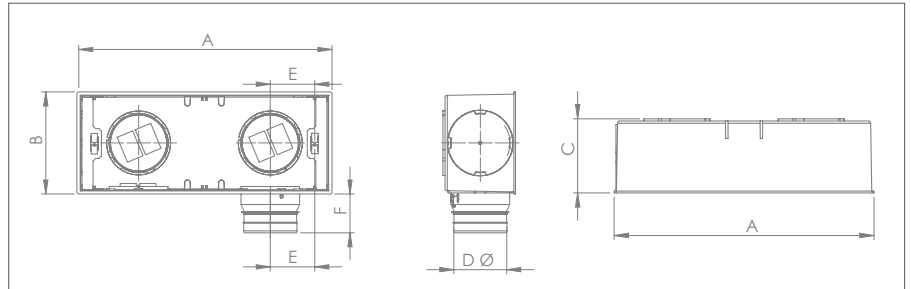

	CODE
WDPE-PB SLIM 300X120	25076

A	B	C	ØD	E	F
300	120	86	63	72.5	45.6

Dimensions in mm

Sleeve (additional for the WDPE slim system)

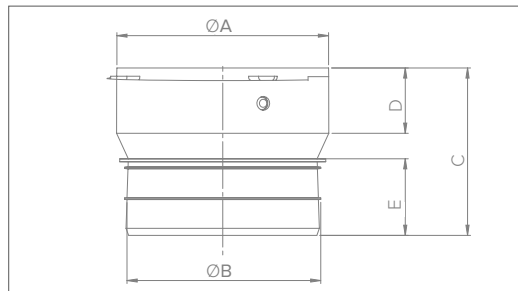
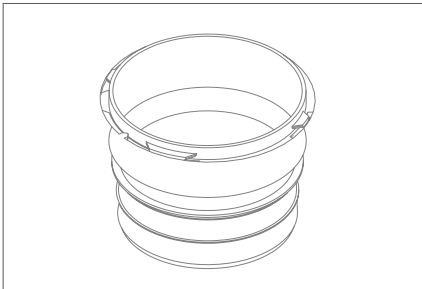

	CODE
WDPE-J SLIM	25077

ØA	ØB	C	D	E
300	120	86	63	72.5

Dimensions in mm

# WDG35 SYSTEM

OVAL

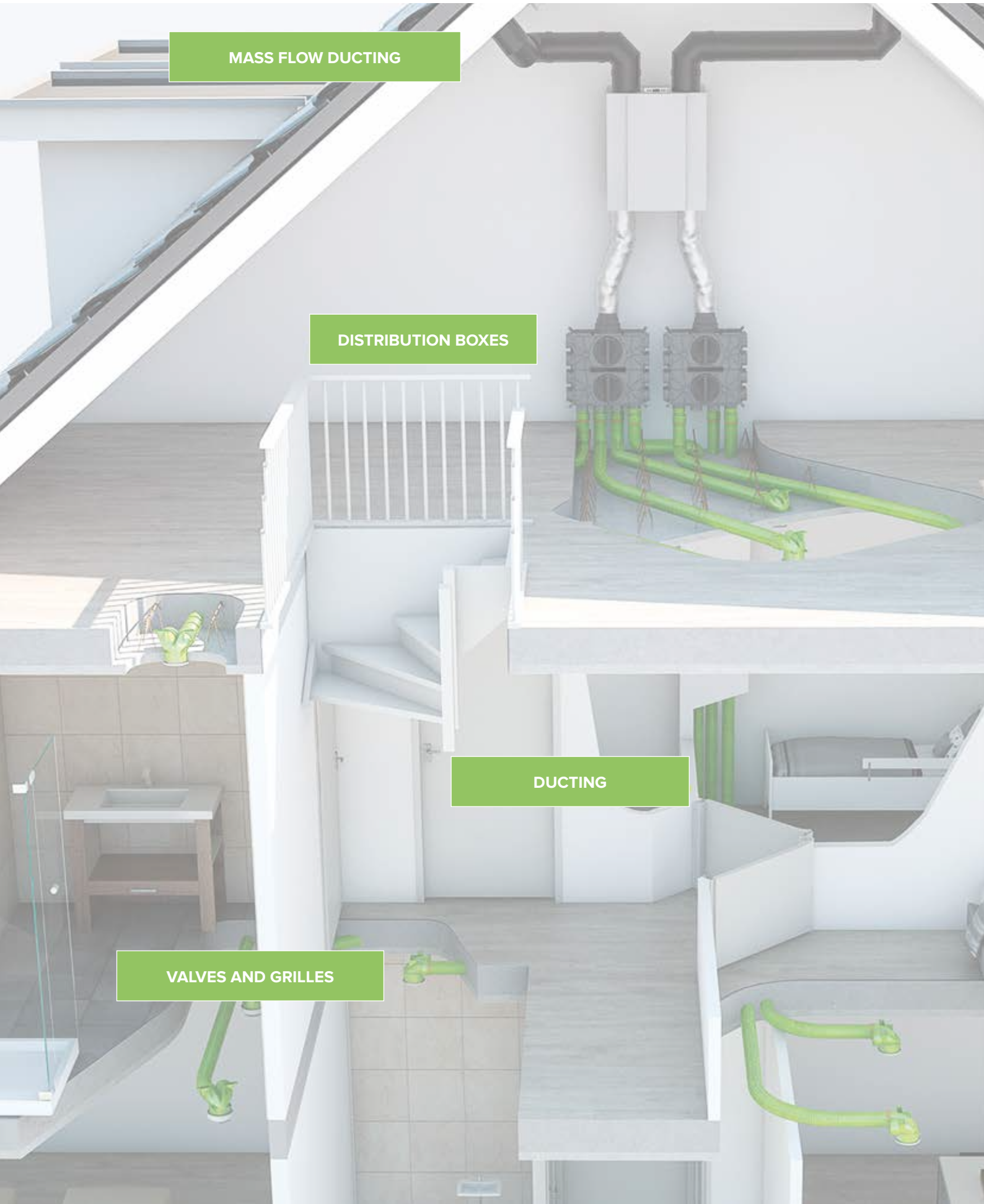

MASS FLOW DUCTING

DISTRIBUTION BOXES

DUCTING

VALVES AND GRILLES

**FOR ALL NEW CONSTRUCTION AND RENOVATION APPLICATIONS.**

Rolled ducting is easy to roll out, cut to size, and fold around obstacles. The ducting can be laid under screeds, suspended under ceilings, and hung on walls.



A complete set of accessories is available for any possible installation, including mixing of circular (**WDG63** and **WDG75**) and oval (**WDG35**) ducts. We know that every market and every situation is different. And that is why we have developed a system that will always work.

# WDG35 SYSTEM

OVAL

## DUCTS

The circular WDG35 ducting enables the efficient distribution of air from the distribution plenums to the various environments. Thanks to its oval section, the ducting is easy to install and ensures minimal pressure drops.



- Quick and easy to install.
- Corrugated external surface to protect against any installation damage.
- Smooth internal surface to minimise pressure drops and ensure long-term cleaning.
- Antistatic and antibacterial properties.
- Suitable for new and renovated buildings.
- Made of exclusively virgin PE granulate.

## DIMENSIONS

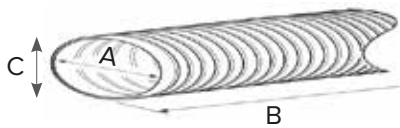

	CODE	A	B	C
WD 35	21478	102	50M	50

Dimensions in mm

## TECHNICAL DATA



WD 35

WD 35 vertical

WD 35 horizontal

Radius [mm]	0		150		200	
	1		1		1	
Duct route	1		1		1	
Qv (Volume) [m³/h]	v [m/s]	(Pa)	v [m/s]	(Pa)	v [m/s]	(Pa)
0	0.0	0.0	0.0	0.0	0.0	0.0
5	0.5	0.3	0.5	0.1	0.5	0.1
10	0.9	0.7	0.9	0.2	0.9	0.3
15	1.4	1.1	1.4	0.6	1.4	0.6
20	1.8	1.7	1.8	1.0	1.8	1.1
25	2.3	2.3	2.3	1.5	2.3	1.8
30	2.7	3.0	2.7	2.2	2.7	2.6
35	3.2	3.8	3.2	3.0	3.2	3.5
40	3.6	4.7	3.6	3.9	3.6	4.6
45	4.1	5.7	4.1	5.0	4.1	5.8
50	4.6	6.8	4.6	6.1	4.6	7.1
55	5.0	8.0	5.0	7.4	5.0	8.6



**WDG-R 63-35**

**TIP**

Use adapter code 21492 WDG-R 63-35 to connect the oval channel to the plenums of the WDG range.

**TECHNICAL DATA**

**WD 35**
**WD 35 vertical**
**WD 35 horizontal**

Radius [mm]	0		150		200	
	1		1		1	
Duct route	1		1		1	
Qv (Volume) [m <sup>3</sup> /h]	v [m/s]	(Pa)	v [m/s]	(Pa)	v [m/s]	(Pa)
0	0.0	0.0	0.0	0.0	0.0	0.0
5	0.2	0.1	0.2	0.0	0.2	0.0
10	0.5	0.3	0.5	0.1	0.5	0.1
15	0.7	0.5	0.7	0.1	0.7	0.2
20	0.9	0.7	0.9	0.2	0.9	0.3
25	1.1	0.9	1.1	0.4	1.1	0.4
30	1.4	1.1	1.4	0.6	1.4	0.6
35	1.6	1.4	1.6	0.8	1.6	0.9
40	1.8	1.7	1.8	1.01	1.8	1.1
45	2.1	2.0	2.1	1.2	2.1	1.4
50	2.3	2.3	2.3	1.5	2.3	1.8
55	2.5	2.6	2.5	1.9	2.5	2.2
60	2.7	3.0	2.7	2.2	2.7	2.6
65	3.0	3.4	3.0	2.6	3.0	3.0
70	3.2	3.8	3.2	3.0	3.2	3.5
75	3.4	4.3	3.4	3.5	3.4	4.0
80	3.6	4.7	3.6	3.9	3.6	4.6
85	3.9	5.2	3.9	4.4	3.9	5.1
90	4.1	5.7	4.1	5.0	4.1	5.8
95	4.3	6.3	4.3	5.5	4.3	6.4
100	4.6	6.8	4.6	6.1	4.6	7.1
105	4.8	7.4	4.8	6.8	4.8	7.8
110	5.0	8.0	5.0	7.4	5.0	8.6

# WDG35 SYSTEM

## OVAL

### DUCTS

The **sealing ring** for the oval duct is an essential component of the WDG35 system for the hermetic sealing of the connections between the ducts, accessories and distribution plenums. The composite material (PP and TPE) makes the sealing ring flexible for easy assembly and the creation of hermetic connections **(1 piece)**.

For the straight connection of the oval duct, for ceiling or wall installations.

Easy to assemble with gasket and sealing ring. Antistatic and antibacterial properties, made from exclusively virgin PP granulate.

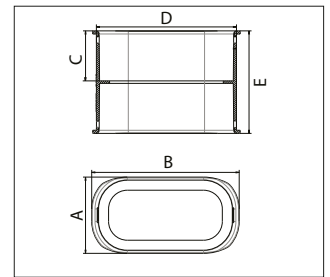
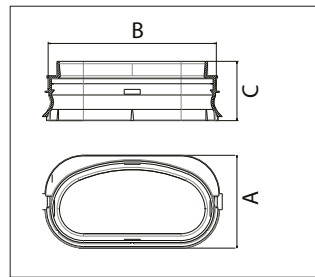

	CODE	ØA	B	C
WDG-OR 35	21485	58	105	37

Dimensions in mm

	CODE	A	B	C	D	E
WDG-J 35	21482	61	118	40	118	82

Dimensions in mm

98 The **regulator** makes it possible to set the air flow for each duct. It is connected directly to the distribution plenum and with the use of adapters it can be connected to any type of duct. The setting can be defined by aeraulic calculations. The air flow can be easily adjusted thanks to the lever without the need to intervene on the system.

Circular/oval connection from WDG63 to WDG35.

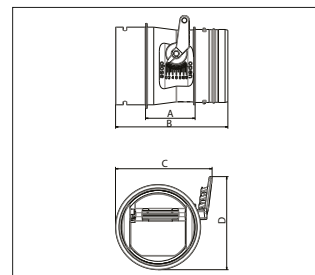

	CODE
WDG-R 63-35	21492

	CODE	A	B	C	D
WDG-RRM	25074	53	120	103	99

Dimensions in mm



## DUCTS

The 90° accessory has been developed to create precise curves with minimal pressure drop around obstacles and to change the direction from horizontal to vertical.

Possibility of making narrow, vertical, or horizontal curved lines for wall, floor, and ceiling installation. Antistatic and antibacterial properties. Made of exclusively virgin PP granulate.

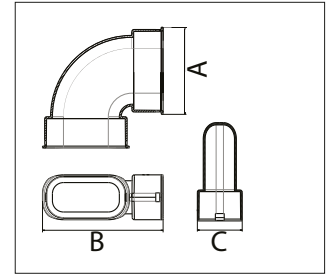
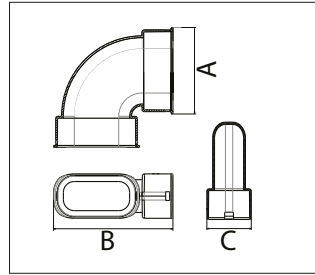

	CODE	A	B	C
WDG-CV 35	21483	107	118	61

Dimensions in mm

	CODE	ØA	B	C
WDG-CH 35	21484	118	164	61

Dimensions in mm

## TECHNICAL DATA



### Horizontal curve

### Vertical curve

Duct route	1		1	
	v [m/s]	(Pa)	v [m/s]	(Pa)
Qv (Volume) [m³/h]				
0	0.0	0.0	0.0	0.0
5	0.5	0.0	0.5	0.1
10	0.9	0.1	0.9	0.3
15	1.4	0.3	1.4	0.6
20	1.8	0.5	1.8	1.1
25	2.3	0.7	2.3	1.7
30	2.7	1.0	2.7	2.4
35	3.2	1.4	3.2	3.3
40	3.6	1.8	3.6	4.3
45	4.1	2.3	4.1	5.5
50	4.6	2.8	4.6	6.8
55	5.0	3.4	5.0	8.2

# WDG35 SYSTEM

OVAL

## DIFFUSION TERMINALS

**The 90° valve adapter** has been developed for ceiling or wall installations. It has been designed to cross most of the structures such as walls, screeds, or false ceilings. The adapter can be cut to size with common equipment and then assembled with the termination of the ventilation system: the air delivery or extraction valve. The adapter has two connections for the oval duct and is supplied with a dust cap on the valve connection (125 mm) and a removable cap on one of the two connections for the oval duct.



- For air delivery and extraction.
- For ceiling or wall installations.
- Easy to cut to the desired size.
- Antistatic and antibacterial properties.
- Made of exclusively virgin PP granulate.

## DIMENSIONS

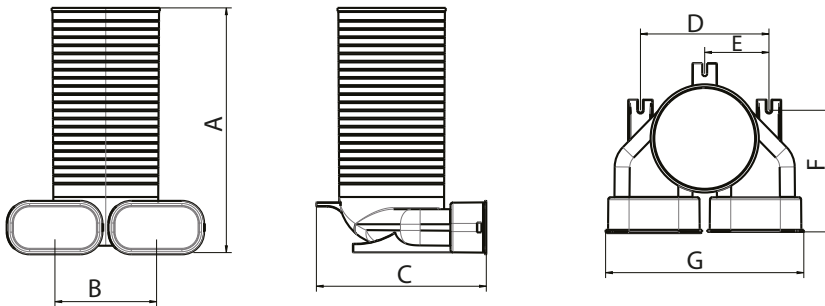

	CODE	A	B	C	D	E	F	G
WDG-PB 125-35	21479	301	125	209	158	79	149	244

*Dimensions in mm*



## TECHNICAL DATA

Duct route	Air delivery				Air extraction			
	1		2		1		2	
Qv (Volume) [m <sup>3</sup> /h]	v [m/s]	(Pa)	v [m/s]	(Pa)	v [m/s]	(Pa)	v [m/s]	(Pa)
0	0.0	0.0	0.0	0.0	0.0	0.0	0.0	0.0
5	0.5	0.1	0.2	0.0	0.5	0.2	0.2	0.0
10	0.9	0.5	0.5	0.1	0.9	0.6	0.5	0.2
15	1.4	1.2	0.7	0.2	1.4	1.4	0.7	0.4
20	1.8	2.1	0.9	0.4	1.8	2.5	0.9	0.7
25	2.3	3.3	1.1	0.6	2.3	4.0	1.1	1.2
30	2.7	4.8	1.4	0.9	2.7	5.7	1.4	1.7
35	3.2	6.5	1.6	1.3	3.2	7.8	1.6	2.3
40	3.6	8.5	1.8	1.6	3.6	10.1	1.8	3.0
45	4.1	10.7	2.1	2.1	4.1	12.8	2.1	3.8
50	4.6	13.3	2.3	2.6	4.6	15.8	2.3	4.7
55	5.0	16.0	2.5	3.1	5.0	19.2	2.5	5.6
60	-	-	2.7	3.7	-	-	2.7	6.7
65	-	-	3.0	4.4	-	-	3.0	7.9
70	-	-	3.2	5.1	-	-	3.2	9.1
75	-	-	3.4	5.8	-	-	3.4	10.5
80	-	-	3.6	6.6	-	-	3.6	11.9
85	-	-	3.9	7.4	-	-	3.9	13.5
90	-	-	4.1	8.4	-	-	4.1	15.1
95	-	-	4.3	9.3	-	-	4.3	16.8
100	-	-	4.6	10.3	-	-	4.6	18.7
105	-	-	4.8	11.4	-	-	4.8	20.6
110	-	-	5.0	12.5	-	-	5.0	22.6



# WDG35 SYSTEM

OVAL

## DIFFUSION TERMINALS

The **180° valve adapter** has been developed for ceiling or wall installations. It has been designed to cross most of the structures such as walls, screeds, or false ceilings. The adapter can be cut to size with common equipment and then assembled with the termination of the ventilation system: the air delivery or extraction valve. The adapter has two connections for the oval duct and comes with a dust cap on the valve connection (125 mm) and a removable cap on one of the two connections for the oval duct.



- For air delivery and extraction.
- For ceiling or wall installations.
- Easy to cut to the desired size.
- Antistatic and antibacterial properties.
- Made of exclusively virgin PP granulate.

102

## DIMENSIONS

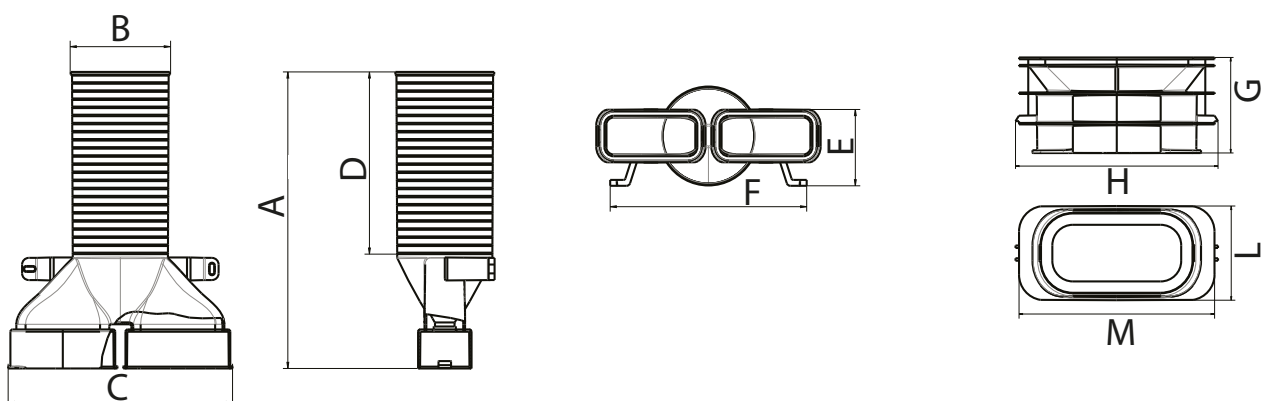

	CODE	A	B	C	D	E	F	G	H	L	M
WDG-PBH 125-35	21480	402	125	304	247	103.5	266	67	143	66	138

Dimensions in mm



## TECHNICAL DATA

Duct route	Air delivery				Air extraction			
	1		2		1		2	
Qv (Volume) [m <sup>3</sup> /h]	v [m/s]	(Pa)	v [m/s]	(Pa)	v [m/s]	(Pa)	v [m/s]	(Pa)
0	0.0	0.0	0.0	0.0	0.0	0.0	0.0	0.0
5	0.5	0.1	0.2	0.0	0.5	0.2	0.2	0.1
10	0.9	0.4	0.5	0.1	0.9	0.6	0.5	0.2
15	1.4	0.9	0.7	0.2	1.4	1.4	0.7	0.5
20	1.8	1.7	0.9	0.3	1.8	2.5	0.9	0.8
25	2.3	2.6	1.1	0.5	2.3	3.9	1.1	1.3
30	2.7	3.8	1.4	0.7	2.7	5.7	1.4	1.8
35	3.2	5.1	1.6	0.9	3.2	7.7	1.6	2.5
40	3.6	6.7	1.8	1.6	3.6	10.1	1.8	3.2
45	4.1	8.5	2.1	1.5	4.1	12.7	2.1	4.1
50	4.6	10.4	2.3	1.8	4.6	15.7	2.3	5.0
55	5.0	12.6	2.5	2.2	5.0	19.0	2.5	6.1
60	-	-	2.7	2.6	-	-	2.7	7.2
65	-	-	3.0	3.1	-	-	3.0	8.5
70	-	-	3.2	3.5	-	-	3.2	9.9
75	-	-	3.4	4.1	-	-	3.4	11.3
80	-	-	3.6	4.6	-	-	3.6	12.9
85	-	-	3.9	5.2	-	-	3.9	14.5
90	-	-	4.1	5.9	-	-	4.1	16.3
95	-	-	4.3	6.5	-	-	4.3	18.2
100	-	-	4.6	7.2	-	-	4.6	20.1
105	-	-	4.8	8.0	-	-	4.8	22.2
110	-	-	5.0	8.8	-	-	5.0	24.4

## DIFFUSION TERMINALS

The 180° valve adapter is suitable for ceiling or wall installations. It has been specifically designed to cross most of the structures such as walls, screeds, or false ceilings.

The adapter can be cut to size with common equipment and then coupled with the termination of the ventilation system: at the air delivery or extraction valve. The adapter has two connections for circular ducts and is supplied with a dust cover on the 125-mm connection and a removable cap on one of the two connections for the circular duct.



	CODE
WDG-PBH 125-63	26032

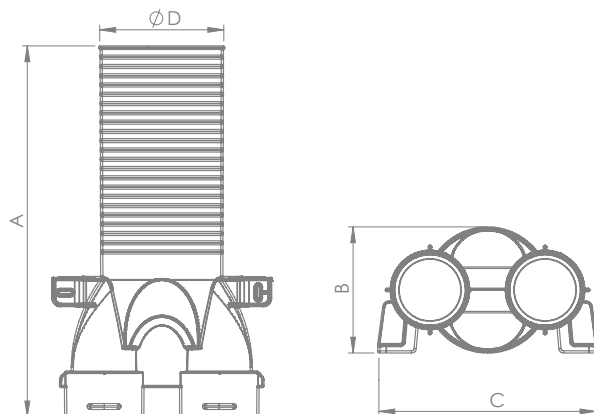

A	B	C	$\varnothing D$
397	133	234	125

Dimensions in mm

# WDG35 SYSTEM

OVAL

## DIFFUSION TERMINALS

**The 90° grille adapter** was originally developed only for air delivery and for floor or wall installations. It can be cut in length with common equipment. It comes with a dust cap on the outlet and a removable cap on one of the two connections for the oval duct. The adapter has two connections for the oval duct and comes with a dust cap on the connection to the rectangular grille and a removable cap on one of the two connections for the oval duct.



- For air delivery.
- For wall or floor installations.
- Easy to cut to the desired size.
- Antistatic and antibacterial properties.
- Made of exclusively virgin PP granulate.

104

## DIMENSIONS

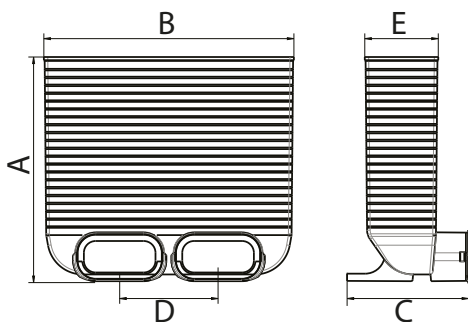

	CODE	A	B	C	D	E
WDG-PB 310X85	21481	287	318	155	125	96

*Dimensions in mm*





## TECHNICAL DATA



Air delivery without grille

Air delivery with grille

Duct route	1				2			
	v [m/s]	(Pa)	v [m/s]	(Pa)	v [m/s]	(Pa)	v [m/s]	(Pa)
0	0.0	0.0	0.0	0.0	0.0	0.0	0.0	0.0
5	0.5	0.1	0.2	0.0	0.5	0.2	0.2	0.1
10	0.9	0.4	0.5	0.1	0.9	0.6	0.5	0.3
15	1.4	0.9	0.7	0.2	1.4	1.4	0.7	0.7
20	1.8	1.6	0.9	0.3	1.8	2.5	0.9	1.2
25	2.3	2.6	1.1	0.5	2.3	3.8	1.1	1.8
30	2.7	3.7	1.4	0.7	2.7	5.5	1.4	2.6
35	3.0	4.5	1.6	1.0	3.0	6.6	1.6	3.6
40	3.2	5.1	1.8	1.3	3.2	7.5	1.8	4.7
45	3.6	6.6	2.1	1.6	3.6	9.8	2.1	5.9
50	4.1	8.4	2.3	2.0	4.1	12.4	2.3	7.3
55	4.6	10.3	2.5	2.4	4.6	15.3	2.5	8.9
60	5.0-	12.5	2.7	2.8	5.0-	18.6	2.7	10.6
65	-	-	3.0	3.3	-	-	3.0	12.4
66	-	-	3.0	3.4	-	-	3.0	12.7
70	-	-	3.2	3.8	-	-	3.2	14.4
75	-	-	3.4	4.4	-	-	3.4	16.5
80	-	-	3.6	5.0	-	-	3.6	18.8
85	-	-	3.9	5.7	-	-	3.9	21.2
90	-	-	4.1	6.4	-	-	4.1	23.8
95	-	-	4.3	7.1	-	-	4.3	26.5
100	-	-	4.6	7.9	-	-	4.6	29.3
105	-	-	4.8	8.7	-	-	4.8	32.3
110	-	-	5.0	9.5	-	-	5.0	35.5

# WDG35 SYSTEM

OVAL

## DIFFUSION TERMINALS

Delivery/recovery launch spigot, manual opening/closing/adjustment system.



	CODE	ØA	B
BOREA 125	23199	125	165

Dimensions in mm

Extraction/delivery spigot made of white thermoplastic polystyrene. Enables air flow regulation with a simple adjustment of the rotating core. To be applied to ceilings, ventilation ducts, false ceilings, etc.

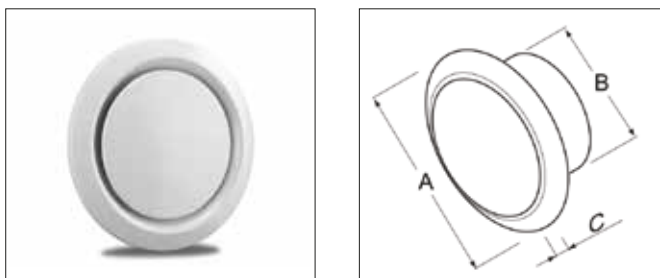

	CODE	ØA	ØB	C
AV 125	22190	166	125	15

Dimensions in mm

Windproof grille made of zinc-coated and powder-coated sheet metal for WDG system, connection diameter from 125 to 180. Equipped with anti-bird protection.

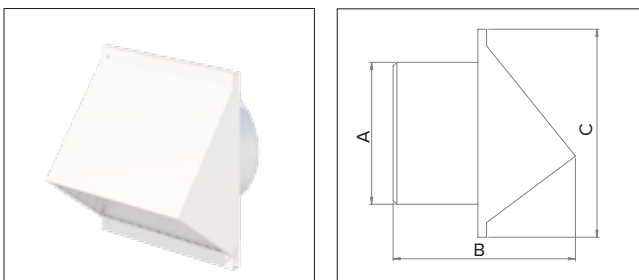

	CODE	A	B	C
GGR-WDG Ø125	26041	125	194	233

Dimensions in mm

## DIFFUSION TERMINALS

Steel extraction/delivery spigots. They enable the regulation of the air flow with a simple adjustment of the rotating core. To be applied to ceilings, ventilation ducts, false ceilings, etc. To be combined with an aesthetic mask (circular, square and rectangular). Revolutionary sound data that guarantee excellent noise levels.

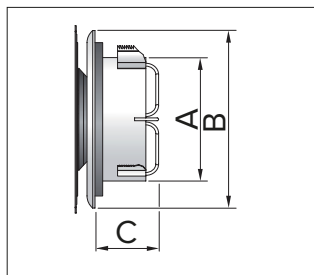

	CODE	ØA	ØB	C
AV PLUS BD 125	26794	114	156	57

Dimensions in mm

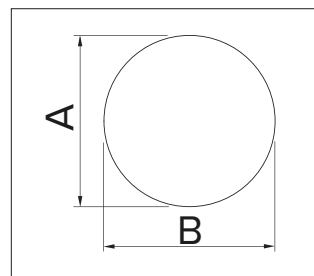
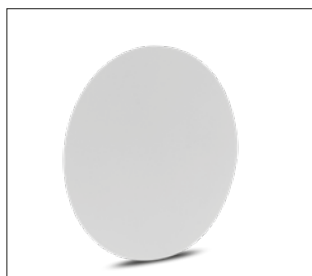

	CODE	ØA	ØB
AV PLUS RND (CIRCULAR)	26797	165	165

Dimensions in mm

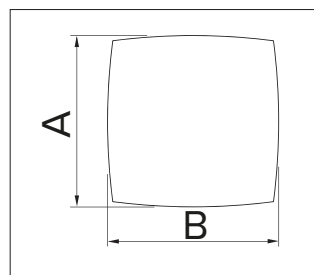
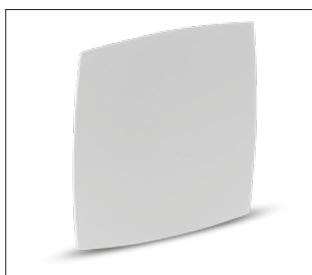

	CODE	A	B
AV PLUS BOW (SQUARE)	26795	165	165

Dimensions in mm

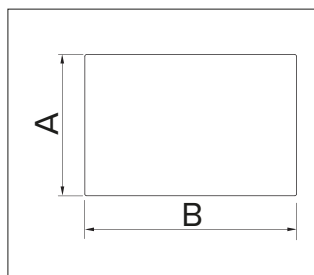
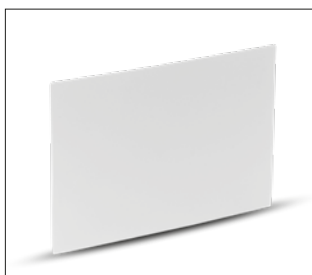

	CODE	A	B
AV PLUS RCT (RECTANGULAR)	26796	165	248

Dimensions in mm

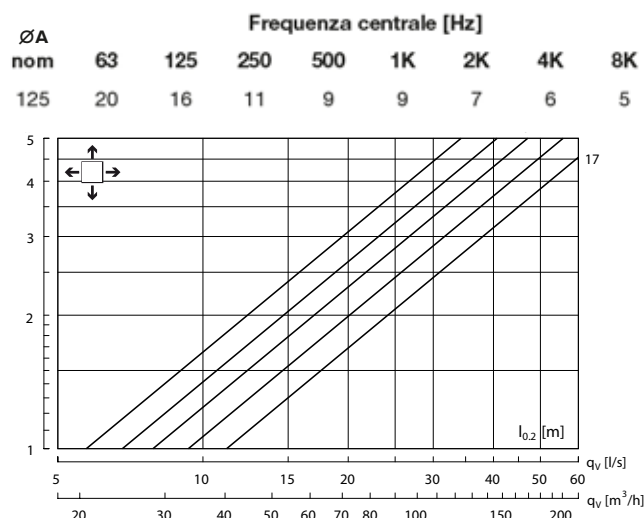

### Delivery curve

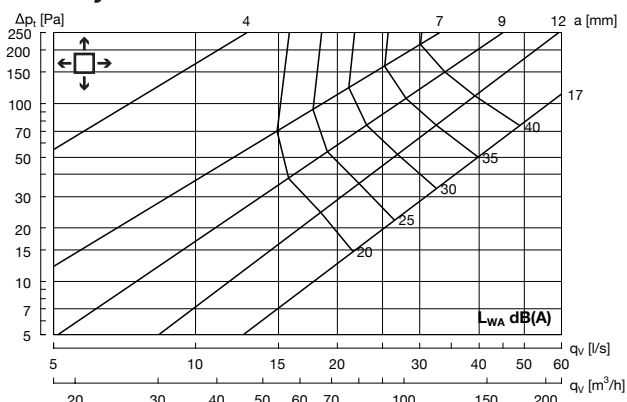

Hz	63	125	250	500	1K	2K	4K	8K
$K_{ak}$	4	-6	-1	0	-6	-11	-15	-15

### Recovery curve

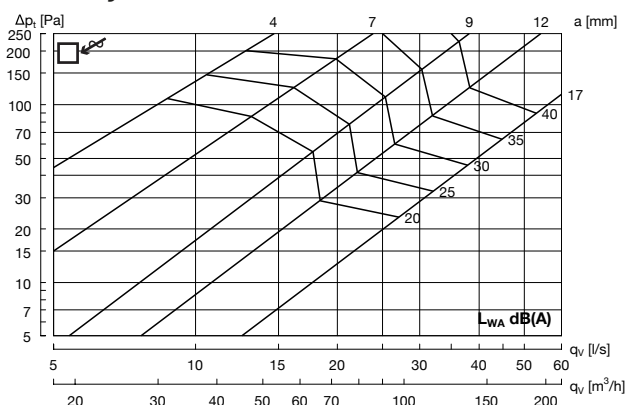

Hz	63	125	250	500	1K	2K	4K	8K
$K_{ak}$	8	-9	-3	-3	-5	-6	-17	-21

# VMC SYSTEM

EXTERNAL CONNECTION

## DUCTS

**Rigid insulated ducting systems ideal for connecting the machine to the outside air inlets.**

In ventilation (heating/cooling), insulating ducts are used to minimise heat loss or prevent condensation from forming inside or outside the duct.

108

Duct that reduces the pressure drop due to its very smooth internal surface. Light, easy to cut, and foldable, resistant to impacts (for example dent free), does not rust. Duct length 2 metres, diameters 125 and 150 mm. Easy to disassemble, which makes maintenance very simple.



## DUCTS

EPE rigid duct, circular section.

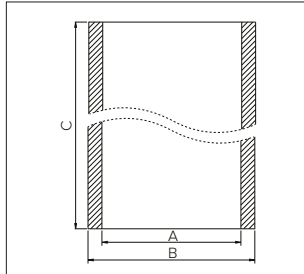

	CODE	ØA	B	C
MD-EPE Ø 125 2M	21468	125	157	2000
MD-EPE Ø 150 2M	21473	150	182	2000
MD-EPE Ø 160 2M	26036	160	-	200

Dimensions in mm

VOLUME [M <sup>3</sup> /H]	PRESSURE DROP [PA]	
	Ø 125	Ø 150
100	1.0	1.0
200	2.7	1.1
300	6.1	2.5
400	10.8	4.5
500	16.9	7.0
600	24.3	10.1

90° curve made of EPE with circular section, diameter 125-150 mm.

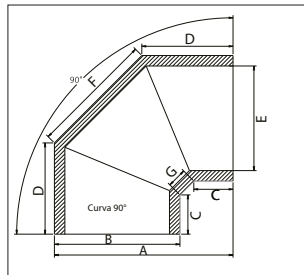

	CODE	ØA	ØB	C	D	ØE	F	G
CR 90° EPE Ø 125	21469	238	157	60	125	125	159	30
CR 90° EPE Ø 150	21474	263	182	60	135	150	181	30
CR 90° EPE Ø 160	26037	274	192	60	140	160	189	30

Dimensions in mm

45° curve made of EPE with circular section, diameter 125-150 mm.

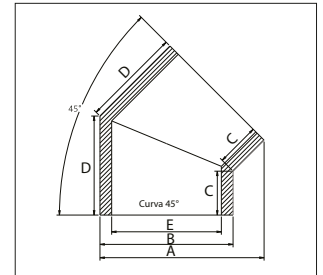

	CODE	ØA	ØB	C	D	ØE
45° CURVE EPE Ø 125	21470	199	157	60	125	125
45° CURVE EPE Ø 150	21475	224	182	60	135	150
45° CURVE EPE Ø 160	26038	274	192	60	140	160

Dimensions in mm

T and Y-shaped joint circular section EPE

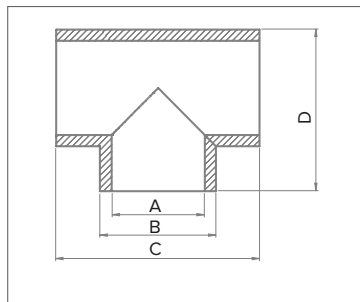

	CODE	A	B	C	D
GN-EPE Ø 125 (T-shaped joint)	26033	125	157	276	216
GN-EPE Ø 160 (T-shaped joint)	26035	160	192	316	254

Dimensions in mm

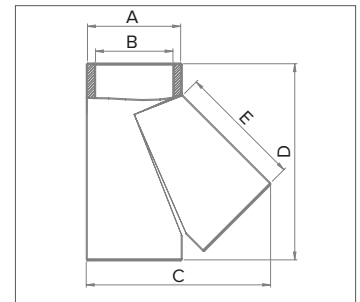

	CODE	A	B	C	D	E
GN-EPE Ø 150 (Y-shaped joint)	26034	150	182	352	377	240

Dimensions in mm

# VMC SYSTEM

## EXTERNAL CONNECTION

Connector made of EPE with 125 and 150 mm diameter. Fixing clip for circular ducts made of EPE.

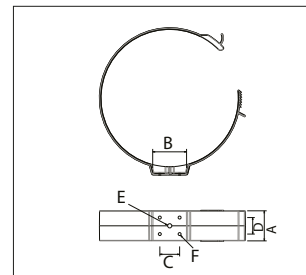
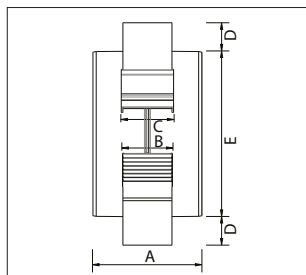

	CODE	A	B	C	D	E
CNN EPE Ø 125	21471	100	45	48	15	125
CNN EPE Ø 150	21476	100	45	48	15	150
CNN EPE Ø 160	26039	100	45	48	15	160

Dimensions in mm

	CODE	A	B	C	D	E	ØF
CLIP EPE Ø 125	21472	45	50	30	25	M8	4.5
CLIP EPE Ø 150	21477	45	50	30	25	M8	4.5
CLIP EPE Ø 160	26040	45	50	30	25	M8	4.5

Dimensions in mm

## EXTERNAL GRILLES

Vertical ejection terminal, connection diameter 125-150 mm.



	CODE
TE-V Ø 125	21486
TE-V Ø 150	21487

Dimensions in mm

Black tile diam. 125/150/160 mm 5-25°/ 25-45°/ 35-55° for roof ejection terminal.



	CODE
TEG Ø 125/150 5-25°	21489
TEG Ø 125/150 25-45°	21490
TEG Ø 125/150 35-55°	21491

Dimensions in mm

Flat tile diam. 125/150 mm for roof ejection terminal. Polypropylene grille with anti-bird protection.



	CODE
TEG Ø 125/150 FLAT	21488

Dimensions in mm

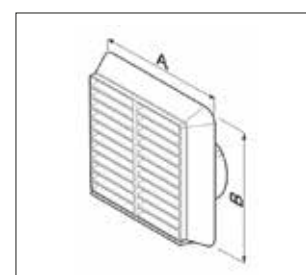

	CODE	A	B
OUTDOOR ANTI-BIRD GRILLE Ø 100	46056	105	105
OUTDOOR ANTI-BIRD GRILLE Ø 125	46058	155	155
OUTDOOR ANTI-BIRD GRILLE Ø 150	46059	185	185

Dimensions in mm



## NOTES

---

---

---

---

---

---

---

---

---

---

---

---

---

---

---

---

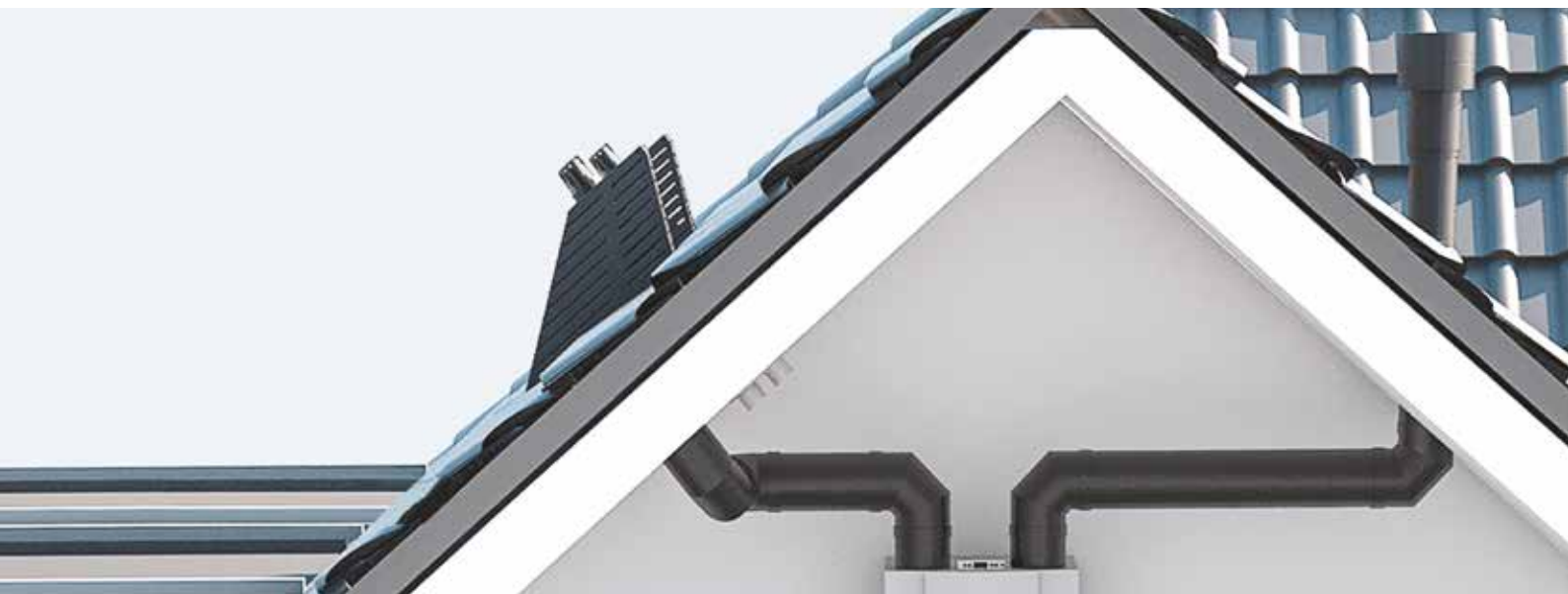

# 204x60 SYSTEM

## RECTANGULAR DUCTING

### DUCTS

Connector for flat duct made of polystyrene.

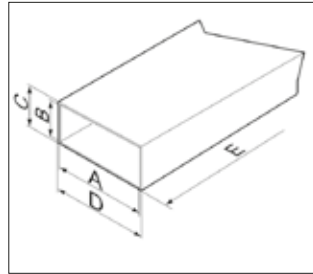

	CODE	A	B	C	D	E
1-M RECTANGULAR PIPE	46155	200	54	60	204	1000
2-M RECTANGULAR PIPE	46157	200	54	60	204	1000

Dimensions in mm

Connector for flat duct made of polystyrene.

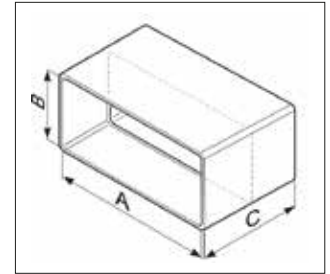

	CODE	A	B	C
SYSTEM 204 FLAT DUCT CONNECTOR	46162	205	60	74

Dimensions in mm

PVC flexible duct rectangular section.

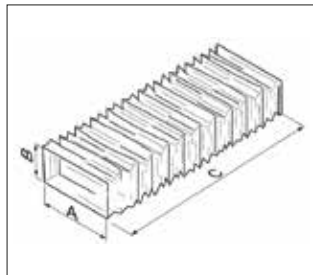

	CODE	A	B	C
PVC FLEX PIPE 204X60	46244	206	62	3M

Dimensions in mm

Horizontal curve rectangular section made of polystyrene.

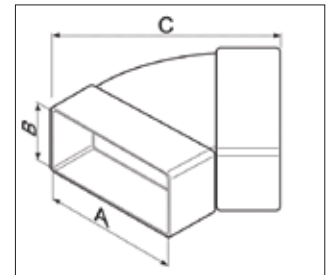

	CODE	A	B	C
SYSTEM 204 HORIZONTAL CURVE 45°	46167	204	60	203
SYSTEM 204 HORIZONTAL CURVE 90°	46159	204	60	244

Dimensions in mm

Flexible/extendable curve rectangular section made of polystyrene/PVC.

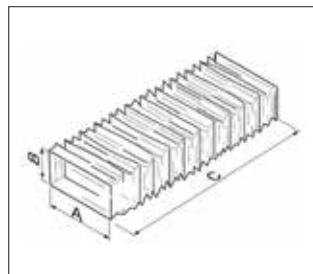

	CODE	A	B	C
SYSTEM 204 FLEXIBLE CURVE	46170	204	60	660

Dimensions in mm

T-junction rectangular section made of polystyrene.

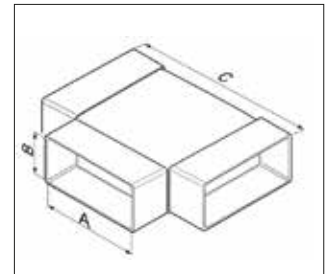

	CODE	A	B	C
SYSTEM 204 T-SHAPED PIECE	46171	204	60	279

Dimensions in mm



## DUCTS



Fixing clip for flat ducts made of polystyrene.

90° curve with rectangular polystyrene adapter.

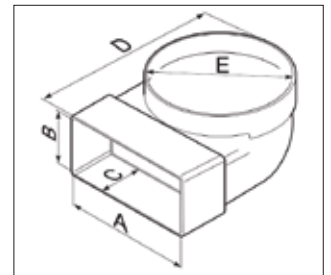
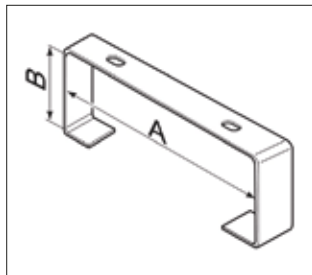

	CODE	A	B
SYSTEM 204 FLAT DUCT FIXING	46163	204	60

Dimensions in mm

	CODE	A	B	C	D	ØE
SYSTEM 204/125 ROTATING ELBOW CURVE	46160	204	60	35	240	125

Dimensions in mm

Vertical curve rectangular section made of polystyrene.

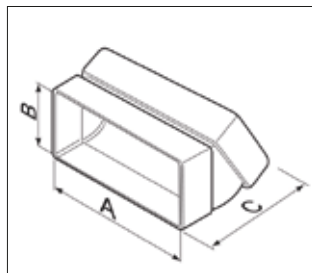

	CODE	A	B	C
SYSTEM 204 VERTICAL CURVE 90°	46164	204	60	98

Dimensions in mm

# 204x60 SYSTEM

## CIRCULAR DUCTING

### DUCTS

Rigid PVC pipe circular section, 1 and 2 metres in length.

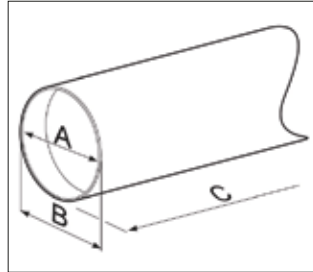

	CODE	ØA	ØB	C
1-M ROUND PIPE Ø 100	46184	100	103	1000
2-M ROUND PIPE Ø 100	46186	100	103	2000
1-M RIGID PIPE Ø 125	46197	125	128	1000
2-M RIGID PIPE Ø 125	46199	125	128	2000
1-M RIGID PIPE Ø 150	46209	149	153	1000
2-M RIGID PIPE Ø 150	46211	149	153	2000

Dimensions in mm

Circular reduction made of polystyrene.

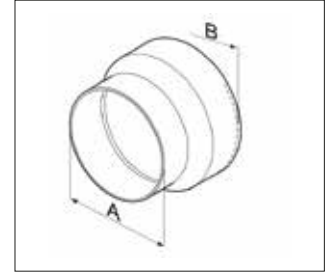

	CODE	ØA	ØB
REDUCER Ø 100-80	46415	80	100
REDUCER Ø 125-100	46312	100	125
REDUCER Ø 150-100	46314	100	150
REDUCER Ø 150-125	46313	125	150
REDUCER Ø 200-150	46315	150	160

Dimensions in mm

114 Flexible PVC duct circular section.

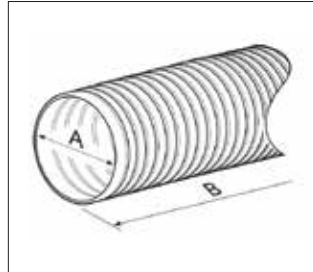

	CODE	ØA	B
PVC FLEX PIPE Ø 102	46224	102	15M
PVC FLEX PIPE Ø 127	46230	127	15M
PVC FLEX PIPE Ø 152	46235	152	15M

Dimensions in mm

T-shaped junction circular section made of polystyrene.

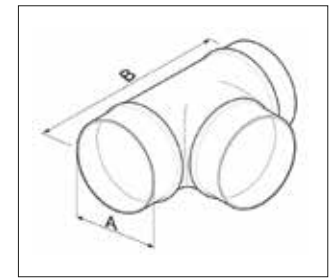

	CODE	ØA	B
T-SHAPED JOINT Ø 100	46193	99	168
T-SHAPED JOINT Ø 125	46203	124	197
T-SHAPED JOINT Ø 150	46214	149	223

Dimensions in mm

Connector for circular duct made of polystyrene.

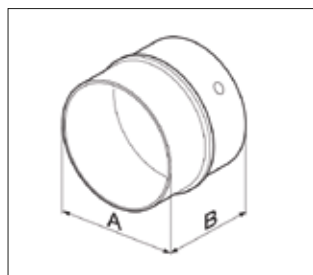

	CODE	ØA	B
PIPE-PIPE CONNECTOR Ø 100	46188	98	60
PIPE-PIPE CONNECTOR Ø 125	46205	124	62
PIPE-PIPE CONNECTOR Ø 150	46216	149	62

Dimensions in mm

## DUCTS

45° and 90° curves circular section made of polystyrene.

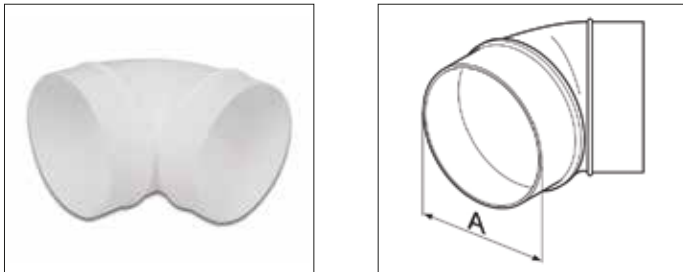

	CODE	ØA
45° ELBOW CURVE Ø 100	46192	99
45° ELBOW CURVE Ø 125	46202	124
90° ELBOW CURVE Ø 100	46191	99
90° ELBOW CURVE Ø 125	46201	124
90° ELBOW CURVE Ø 150	46213	149

*Dimensions in mm*

Fixing clip for circular duct made of polystyrene.

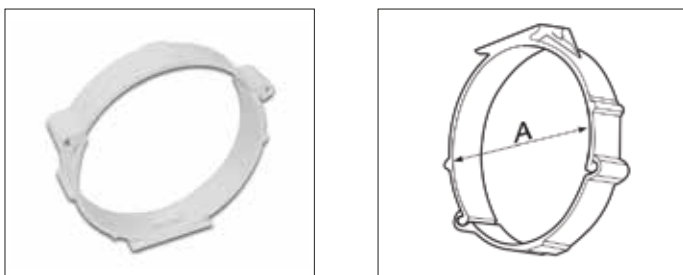

	CODE	ØA
CLIP Ø 100	46195	99
CLIP Ø 125	46204	124
CLIP Ø 150	46217	180

*Dimensions in mm*

Manual duct calibration damper.



	CODE
RRM Ø 80	24825
RRM Ø 100	24827
RRM Ø 125	24828
RRM Ø 150	24829

Duct flow regulator made of thermoplastic material. Maximum temperature 60°C. Complete with rubber gasket. Activated by pressures between 50 and 200 Pa.



	CODE	ØA
RD 15 M/H Ø 80	23050	80
RD 30 M/H Ø 80	23052	80
RD 45 M/H Ø 80	23053	80
RD 15 M/H Ø 100	23056	100
RD 30 M/H Ø 100	23058	100
RD 45 M/H Ø 100	23059	100
RD 60 M/H Ø 100	23061	100
RD 75 M/H Ø 100	23062	100
RD 90 M/H Ø 100	23063	100
RD 15 M/H Ø 125	23066	126
RD 30 M/H Ø 125	23068	126
RD 45 M/H Ø 125	23069	126
RD 60 M/H Ø 125	23071	126
RD 75 M/H Ø 125	23072	126
RD 90 M/H Ø 125	23073	126
RD 120 M/H Ø 125	23075	126
RD 150 M/H Ø 125	23076	126
RD 180 M/H Ø 125	23077	126
RD 120 M/H Ø 150	23079	150
RD 150 M/H Ø 150	23080	150
RD 180 M/H Ø 150	23081	150
RD 210 M/H Ø 150	23082	150
RD 240 M/H Ø 150	23083	150
RD 270 M/H Ø 150	23084	150
RD 300 M/H Ø 150	23085	150
RD 210 M/H Ø 200	23095	200
RD 240 M/H Ø 200	23096	200
RD 270 M/H Ø 200	23097	200
RD 350 M/H Ø 200	23098	200
RD 300 M/H Ø 201	23099	200

*Dimensions in mm*

# VORT PLENUM

PPE

## CENTRALISED VENTILATION

### DISTRIBUTION PLENUM

#### Vort plenum 6+1

for air delivery/extraction ducts

**up to 6 rooms+kitchen**

Ø pipes: inlet 125 mm outlets 1x125 mm - 6x80 mm



#### Vort Plenum 5+1 AR

for air extraction ducts

**up to 5 rooms+kitchen**

self-adjusting spigots pipes  
Ø: inlet 1x125 mm outlets 125 mm + 5x80 mm

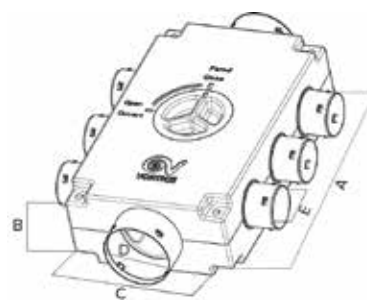
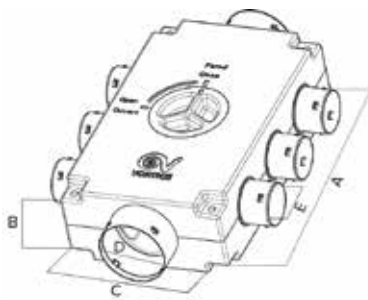

	CODE	A	B	C	ØD	ØE
VORT PLENUM 6+1	22343	490	150	300	125	77.5

Dimensions in mm

	CODE	A	B	C	ØD	ØE
VORT PLENUM 5+1 AR	22347	490	150	300	125	77.5

Dimensions in mm

### ACCESSORIES

Flow regulator 15 m<sup>3</sup>/h and 30 m<sup>3</sup>/h for 5+1 R and 6+1 plenum.



	CODE
REGULATOR 15	22324
REGULATOR 30	22325

### CAP

Plenum cap 5+1 AR and 6+1.



	CODE
RED Ø 80 CAP	22605
GREY Ø 80 CAP	22606

## DUCTS

Flexible pipe with thermal and acoustic insulation. Internal duct made of perforated aluminium, insulation made of glass wool, external covering made of aluminium film reinforced with fiberglass.

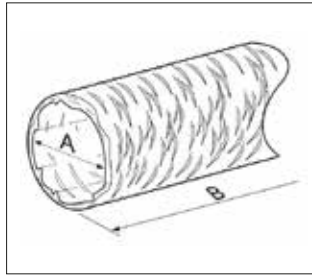

	CODE	ØA	B
AFD-ACU 80-10	23201	82	10M
AFD-ACU 125-10	23203	127	10M

Dimensions in mm

Aluminium flexible duct with circular section.

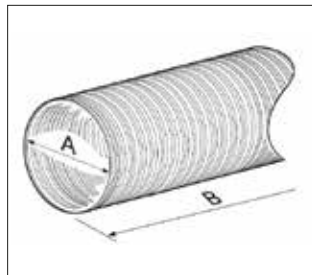

	CODE	ØA	B
10-M ALUMINIUM PIPE Ø 80	46257	82	10M
10-M ALUMINIUM PIPE Ø 127	46259	127	10M

Dimensions in mm

## DIFFUSION TERMINALS

Intake/delivery spigot not adjustable.

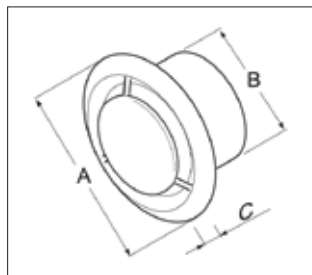

	CODE	ØA	ØB	C
EXTRACTION SPIGOT Ø 80	22326	119	80	19
EXTRACTION SPIGOT Ø 125	22327	169	125	27

Dimensions in mm

# GENERIC COMPONENTS

## GENERIC COMPONENTS

### DUCTS

Flexible aluminum pipe with circular section glass wool insulation.

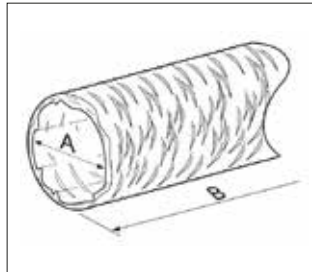

	CODE	ØA	B
10-M INSULATED AL. PIPE Ø 102	46271	102	10M
10-M INSULATED AL. PIPE Ø 127	46272	127	10M
10-M INSULATED AL. PIPE Ø 154	46428	154	10M
10-M INSULATED AL. PIPE Ø 202	46274	202	10M
10-M INSULATED AL. PIPE Ø 254	46276	254	10M
10-M INSULATED AL. PIPE Ø 315	46278	315	10M

Dimensions in mm

Silencer pipe.

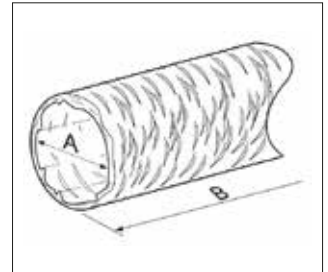

	CODE	ØA	B
SILENCER PIPE Ø 125	22366	125	500
SILENCER PIPE Ø 150	22316	150	500

Dimensions in mm

Aluminium flexible duct with circular section.

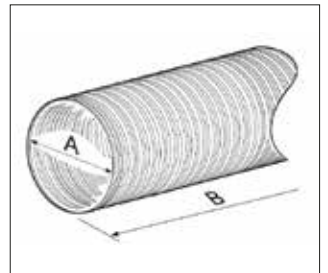

	CODE	ØA	B
10-M ALUMINIUM PIPE Ø 102	46258	102	10M
10-M ALUMINIUM PIPE Ø 127	46259	127	10M
10-M ALUMINIUM PIPE Ø 152	46260	152	10M
10-M ALUMINIUM PIPE Ø 160	46261	160	10M
10-M ALUMINIUM PIPE Ø 203	46263	203	10M
10-M ALUMINIUM PIPE Ø 254	46264	254	10M
10-M ALUMINIUM PIPE Ø 315	46266	315	10M
10-M ALUMINIUM PIPE Ø 80	46257	82	10M

Dimensions in mm

118

Flexible pipe with thermal and acoustic insulation. Internal duct made of perforated aluminium, insulation made of glass wool, external covering made of aluminium film reinforced with fiberglass.

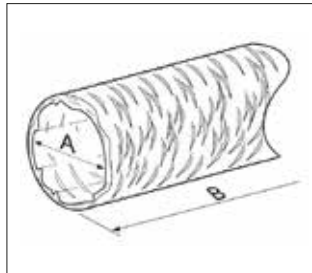

	CODE	ØA	B
AFD-ACU 80-10	23201	82	10M
AFD-ACU 100-10	23202	102	10M
AFD-ACU 125-10	23203	127	10M
AFD-ACU 150-10	23204	152	10M
AFD-ACU 160-10	23205	162	10M

Dimensions in mm



## DUCTS

Circular aphonic transit grille with telescopic sleeve for 90 to 170 mm thicknesses. White powder-coated zinc-coated steel deflectors. Perforated stainless steel through section - internal insulation made of mineral wool.

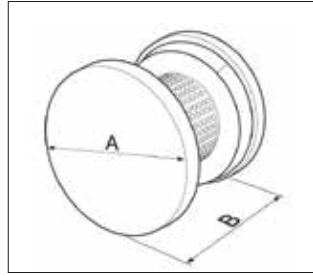

	CODE	ØA	B
GTA Ø 100	23207	160	90/170
GTA Ø 125	23208	200	90/170

Dimensions in mm

Rectangular aphonic transit grille with telescopic sleeve for 90 to 170 mm thicknesses. White powder-coated zinc-coated steel deflectors. Pre-drilled through section made of stainless steel, internal insulation made of mineral wool.

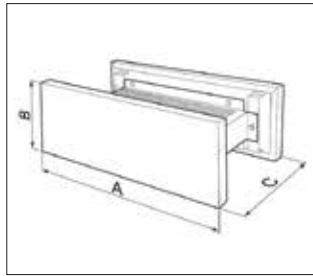

	CODE	A	B	C
GTA 400X100	23206	400	130	90/170

Dimensions in mm

Fixing clip for circular ducts made of aluminium.



	CODE
CLIP Ø 100	46309
CLIP Ø 125	46310

# GENERIC COMPONENTS

## GENERIC COMPONENTS

### DIFFUSION TERMINALS

Delivery/recovery spigot with adjustable flow. White polystyrene casing, manual opening/closing/adjustment system.

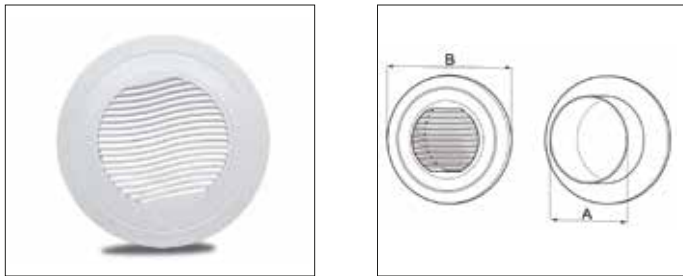

	CODE	ØA	ØB
BOREA 80	23198	80	110
BOREA 125	23199	125	165

Dimensions in mm

Self-adjusting extraction spigot. White polystyrene casing. Internal self-regulating module activated by pressures between 50 and 160 Pa. Code 23197 Vortpack Alize Self Insulation - accessory component that can be combined with Vortpack Alize spigots.

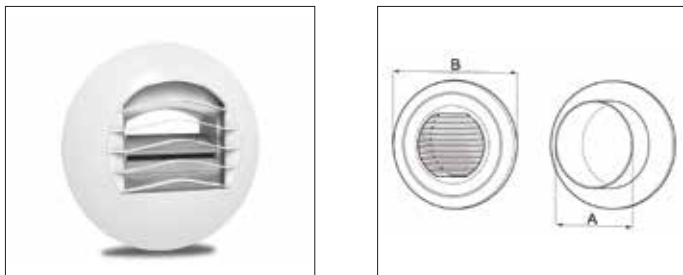

	CODE	ØA	ØB
VORTPACK ALIZE' AUTO TEMPO 20/75	24820	125	160
VORTPACK ALIZE' AUTO TEMPO 30/90	24821	125	160
VORTPACK ALIZE' AUTO TEMPO 45/105	24822	125	160
VORTPACK ALIZE' AUTO TEMPO 45/120	24823	125	160
VORTPACK ALIZE' AUTO TEMPO 45/135	24824	125	160
VORTPACK ALYZE AUTO 15	22912	125	160
VORTPACK ALYZE AUTO 30	22911	125	160
VORTPACK ALYZE AUTO 45	23193	125	160
VORTPACK ALYZE AUTO 60	23194	125	160
VORTPACK ALYZE AUTO 75	23195	125	160
VORTPACK ALYZE AUTO 90	23196	125	160
VORTPACK ALYZE AUTO ACOUSTIC INSULATION	23197	125	160

Dimensions in mm

Extraction/delivery spigot made of white thermoplastic polystyrene. Enables air flow regulation with a simple adjustment of the rotating core. To be applied to ceilings, ventilation ducts, false ceilings, etc.

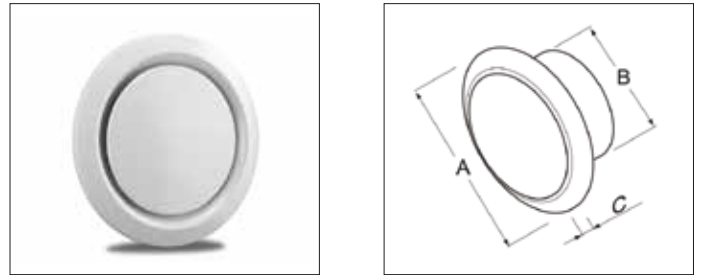

	CODE	ØA	ØB	C
AV 100	22189	140	100	13
AV 125	22190	166	125	15
AV 150	22191	204	150	17
AV 160	22192	204	160	17
AV 200	22193	242	200	17

Dimensions in mm

High induction spigot 300x100, with perforated front made of white powder-coated zinc-coated steel. Suitable for delivery and extraction.

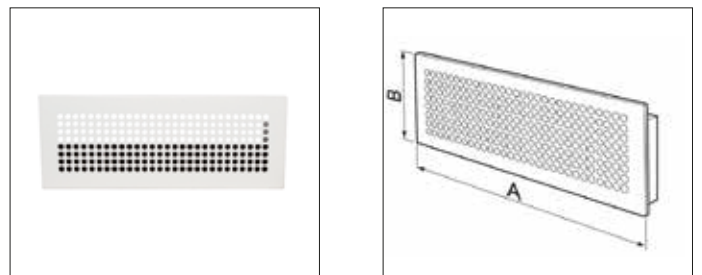

	CODE	A	B
WD-BF 200X100 (for WD system)	23656	200	100
WD-BF 300X100 (for WD system)	23215	300	100
WDG-BF 310X85 (for WDG system)	21094	310	85
WDPE-BF 193X140 (for WDPE system)	26799	193	140
WDPE-BF 366X140 (for WDPE system)	25073	366	140
WDPE-BF 540X140 (for WDPE system)	25075	540	140
WDPE-BF 330X150 (for WDPE system) SLIM	25078	330	150

Dimensions in mm



## DIFFUSION TERMINALS

Duct counterframe.

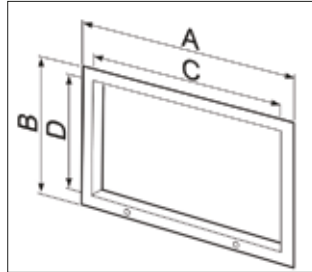

	CODE	A	B	C	D
CO 200X100	22227	235	135	200	100
CO 300X100	22228	335	135	300	100
CO 300X150	22229	388	185	300	150
CO 500X200	22230	535	235	500	200

Dimensions in mm

Zinc-coated steel plenum for grilles.

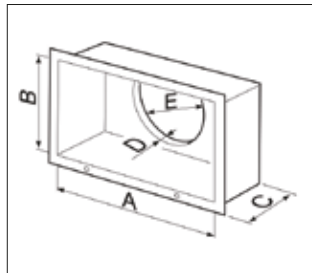

	CODE	A	B	C	D	ØE
PGB 200X100	22231	200	100	200	50	97
PGB 300X100	22232	300	100	200	50	97
PGB 300X150	22233	300	150	200	50	125
PGB 500X200	22234	500	200	200	50	160
PGB 500X350	22244	500	350	200	50	315

Dimensions in mm

Circular diffuser to be applied to ceilings, ventilation ducts, false ceilings, etc.

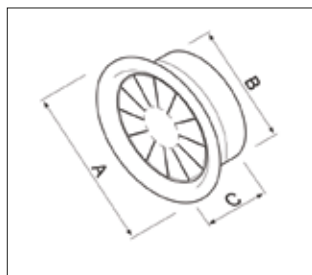

	CODE	A	B	C
DE 160	22237	260	157	84
DE 250	22238	350	247	84
DE 315	22239	415	312	84

Dimensions in mm

Rectangular delivery/return spigot with fixed horizontal fins and movable vertical fins, with manual adjustment. To be applied to square or rectangular ventilation ducts using a counter frame, or to circular ducts using the related plenums.

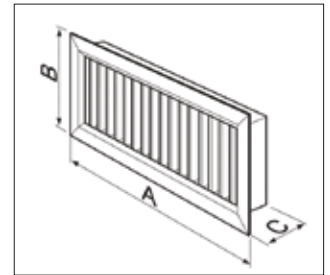

	CODE	A	B	C
BM 200X100	22215	200	100	85
BM 300X100	22216	300	100	85
BM 300X150	22217	300	150	85
BM 500X200	22218	500	200	85

Dimensions in mm

Return grille with fixed inclined fins, pitch 25 mm, made of natural anodised extruded aluminium, fixing with clips.

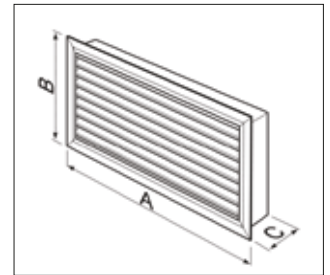

	CODE	A	B	C
GA 200X100	22219	200	100	25
GA 300X100	22220	300	100	25
GA 300X150	22221	300	150	25
GA 500X200	22222	500	200	25
GA 500X350	22243	500	350	25

Dimensions in mm

# GENERIC COMPONENTS

## GENERIC COMPONENTS

### DIFFUSION TERMINALS

**Self-regulating air inlet suitable for applications in single-flow VMC systems.**

Self-regulating air inlet 15 m<sup>3</sup>/h

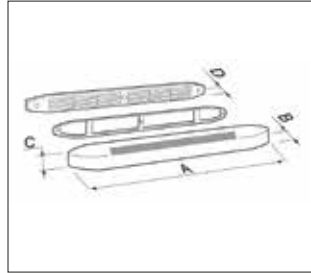

	CODE	A	B	C	D
EA 15 BL	91012	295	20	23	12
EA 30 BL	91014	295	20	23	12

*Dimensions in mm*

Self-regulating delivery spigot with acoustic thickness.

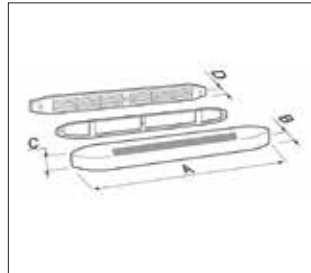

	CODE	A	B	C	D
EAA22 BL	91016	400	38	36	12
EAA30 BL	91018	400	38	36	12
EAA45 BL	91035	400	38	36	12

*Dimensions in mm*

Self-adjusting delivery spigot with acoustic thickness and Ø 125 rear connection (30 m<sup>3</sup>/H).



	CODE	A	B	C
EM A 30	24639	220	150	52

*Dimensions in mm*

## EXTERNAL GRILLES

Polypropylene grille with anti-bird protection.

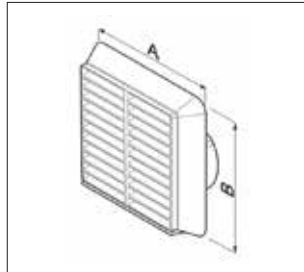

	CODE	A	B
OUTDOOR ANTI-BIRD GRILLE Ø 100	46056	155	155
OUTDOOR ANTI-BIRD GRILLE Ø 125	46058	155	155
OUTDOOR ANTI-BIRD GRILLE Ø 150	46059	185	185

Dimensions in mm

Gravity grille to be installed in the wall. It prevents the return of air and objects from outside. Entirely made of UV-resistant shockproof thermoplastic resin.

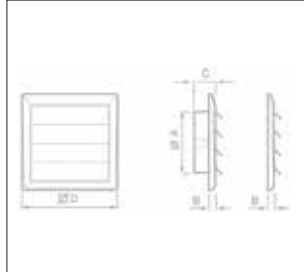

	CODE	ØA	B	C	D
GGR 100	22332	99	8	28	140
GGR 120/125	22333	119	8	28	160
GGR 150/160	22334	155	8	28	198
GGR 200	22335	199	14	28	254
GGR 250	22336	249	14	28	299
GGR 315	22337	324	14	28	391

Dimensions in mm

Windproof grille made of zinc-coated and powder-coated sheet metal for WDG system, connection diameter from 125 to 180. Equipped with anti-bird protection.

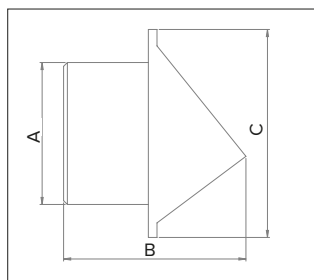

White polypropylene expulsion grille with gravity shutter and rain cover.

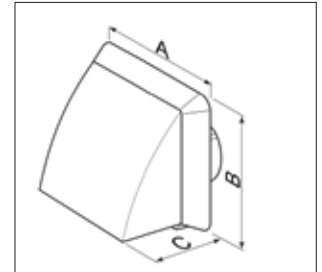

	CODE	A	B	C
WHITE ANTI-WIND GRILLE Ø 100	46072	155	155	60
WHITE ANTI-WIND GRILLE Ø 125	46074	155	155	70

Dimensions in mm

Spacer flange for external wiring.

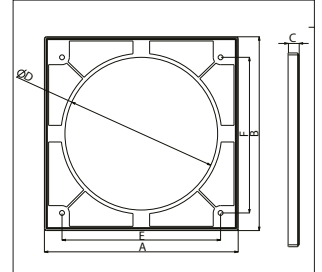

	CODE	A	B	C	ØD	E	F
SPACER FLANGE Ø 100/4	22253	140	140	12	100	105	102
SPACER FLANGE Ø 120/5	22254	160	160	12	120	125	120
SPACER FLANGE Ø 150/6	22255	200	200	12	160	160	162

Dimensions in mm

	CODE	A	B	C
GGR-WDG Ø125	26041	125	194	233
GGR-WDG Ø150	26042	150	194	233
GGR-WDG Ø160	26043	160	194	233
GGR-WDG Ø180	26044	180	200	268

Dimensions in mm

# FILTER BOX AND HEATERS

## FILTERS

The AF range air filters have been designed to enable remote filtration in forced ventilation systems and especially to be coupled to ventilation units. The filter media is composed of fibers coated with a highly adhesive substance to improve the collection of dust. A metal wire structure keeps the mattress flat to facilitate the uniform passage of air. The container is made of zinc-coated steel with an inspection hatch that can be easily opened for the ordinary maintenance of the filter elements. The connection with the ducts is provided with circular joints with unified diameters of 100-125-150-160-200-250-315 mm (DIN 24145).



- Intended for indoor environments with max temperature of 60 °C.
- They have the function of separating ordinary impurities such as: dust, fluff, dirt, etc.
- It is connected to the system by forced insertion on two cylindrical zinc-coated steel connections with built-in circular T-shaped rubber gaskets.

## DIMENSIONS

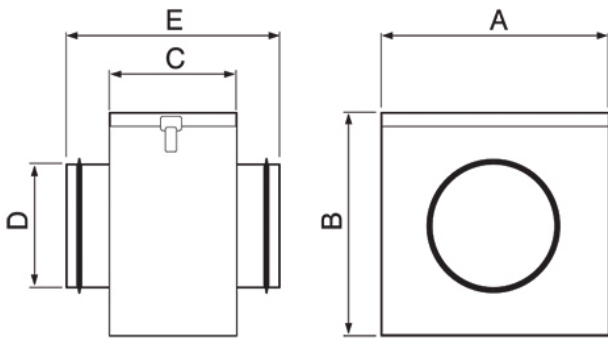

	CODE	A	B	C	ØD	E	KG
AF 100	22793	210	170	125	100	227	2.1
AF 125	22794	220	205	145	125	252	2.1
AF 150	22799	270	235	160	150	267	2.3
AF 160	22795	270	235	160	160	267	2.3
AF 200	22787	320	275	185	200	302	3.5
AF 250	22788	355	320	235	250	352	3.5
AF 315	22789	430	390	335	315	452	6.1

Dimensions in mm

## CURVES

Graph to calculate the air flow rate based on the average speed.

Initial pressure drop curves, filtration class G4.

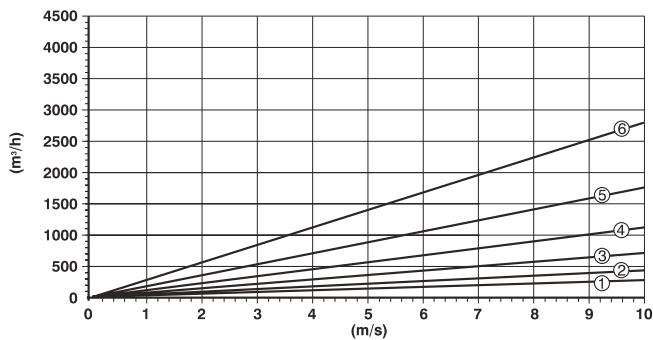

- ① AF - 100
- ② AF - 125
- ③ AF - 150 AF - 160
- ④ AF - 200
- ⑤ AF - 250
- ⑥ AF - 315

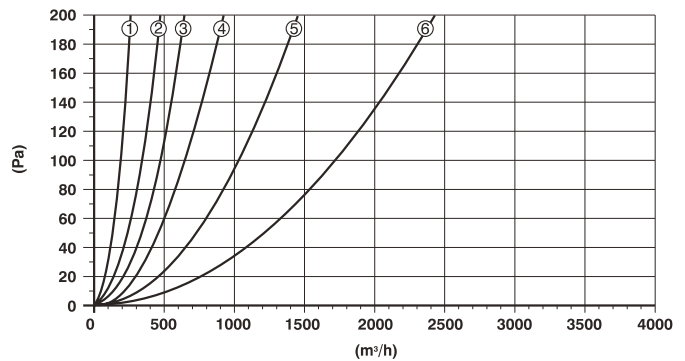

- ① AF - 100
- ② AF - 125
- ③ AF - 150 AF - 160
- ④ AF - 200
- ⑤ AF - 250
- ⑥ AF - 315

## FILTERS

The FB range air filters have been designed to enable remote filtration in forced ventilation systems. These appliances have the function of separating ordinary impurities such as: dust, fluff, dirt, etc. In the case of use in combination with products already originally equipped with filters, in order not to compromise performance, we recommend removing them upon installation.

The filter media is composed of composite polypropylene (filter F7). The container is made of zinc-coated steel with an inspection hatch that can be easily opened for the ordinary maintenance of the filter elements. The connection with the ducts is provided with circular joints with unified diameters of 200-250-315-355-450 mm (DIN 24145). The FB range air filters are intended for use in indoor environments with a maximum temperature of 70 °C (with F7 filter).



- Intended for use in indoor environments with a maximum temperature of 70 °C (with F7 filter)
- Filtration class: F7;
- Filter media: non-flammable synthetic microfibers
- Maximum operating temperature: 70 °C
- It is connected to the system by forced insertion on two cylindrical zinc-coated steel connections with built-in circular T-shaped rubber gaskets.

## DIMENSIONS

125

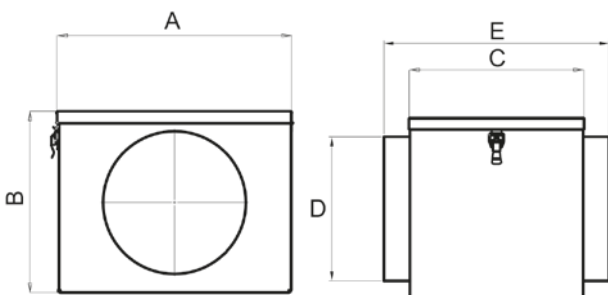

	CODE	A	B	C	D	E	KG
FB 500 Ø 200	24139	240	285	300	200	390	6.5
FB 800 Ø 250	24140	410	315	300	250	440	9
FB 1200 Ø 315	24141	470	370	600	315	735	16
FB 2000 Ø 315	24142	560	485	600	315	735	20
FB 2500/3000 Ø 350	24143	630	500	700	355	830	27
FB 4000/5000 Ø 450	24145	710	608.5	900	450	1080	34
FB 6000 Ø 450	24147	710	805	900	450	1080	40

*Dimensions in mm*

## CURVES

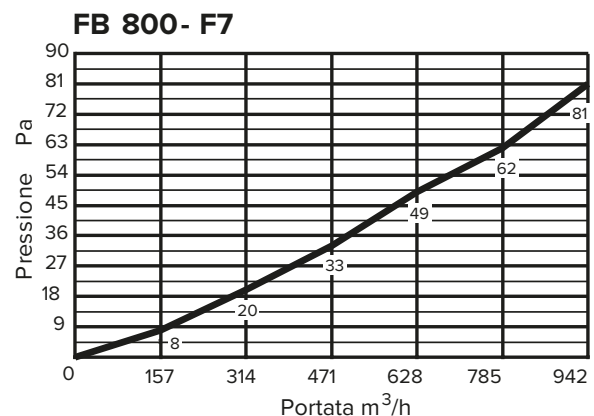
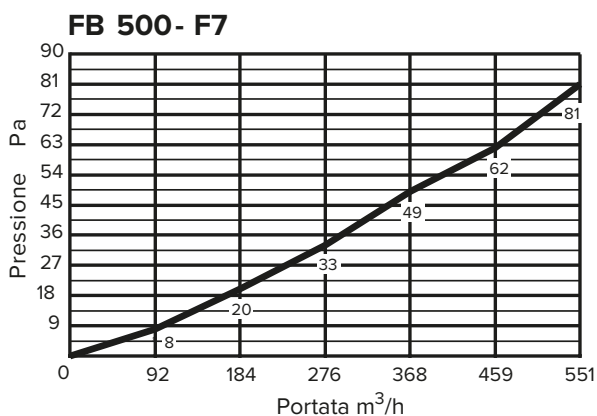

# FILTER BOX AND HEATERS

## FILTERS

### CURVES

**FB 1200 - F7**

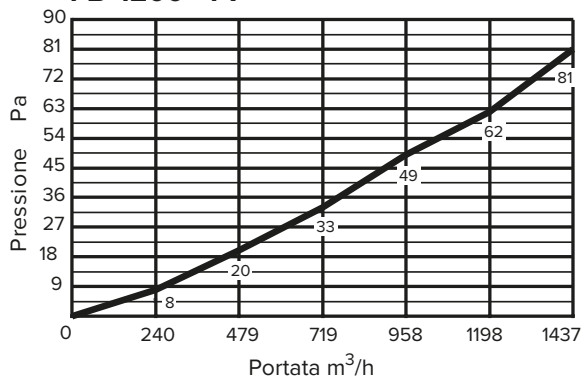

**FB 2000 - F7**

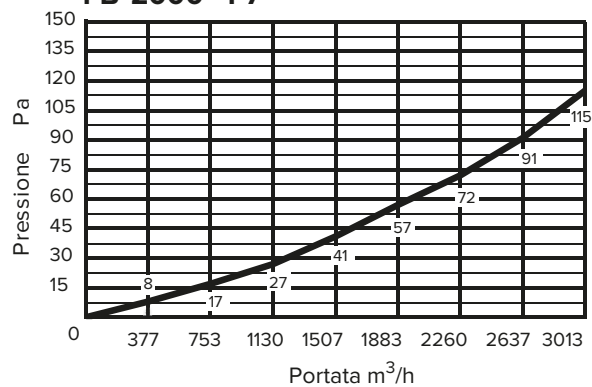

**FB 2500/3000 F7**

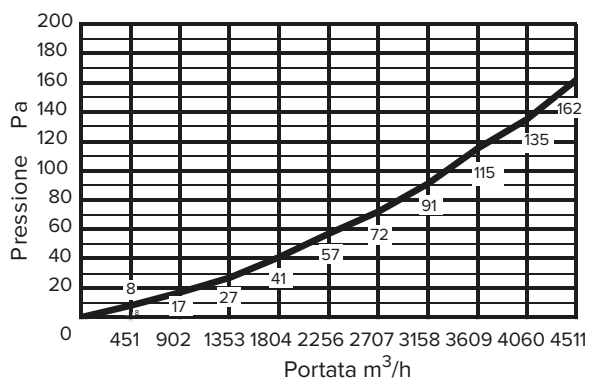

**FB 4000/5000 - F7**

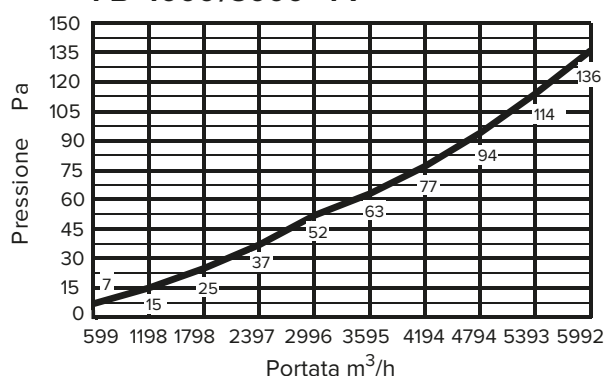

**FB 6000 - F7**

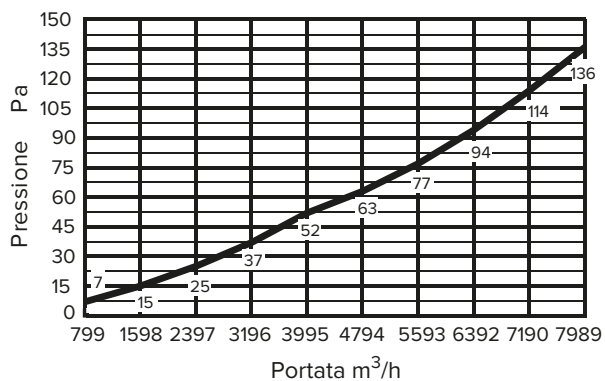



## HEATERS

Heater to be installed in the ventilation system, always downstream of the fan, and/or the noise attenuator/air filter. To optimise the efficiency of the heater it is possible, by means of regulators, to adjust the thermal power according to the desired temperature in the room. The installation must always be carried out in indoor spaces, with an ambient temperature between -30 °C and +50 °C, with free air, without dust, fluff, and chemical impurities.

The casing is made of zinc-coated sheet metal with T-shaped rubber gaskets on both sides, diameters for standard circular ducts 100 125-150-160-200-250-315 mm (DIN 24145).



- Equipped with circular section electric batteries consisting of armoured elements made of stainless steel.
- To be used in indoor places with ambient temperature from +30 °C to +50 °C with free air without dust or chemical impurities.
- Degree of protection of the electrical connection box IP43.
- Does not require special maintenance except for periodic operating checks.

## DIMENSIONS

127

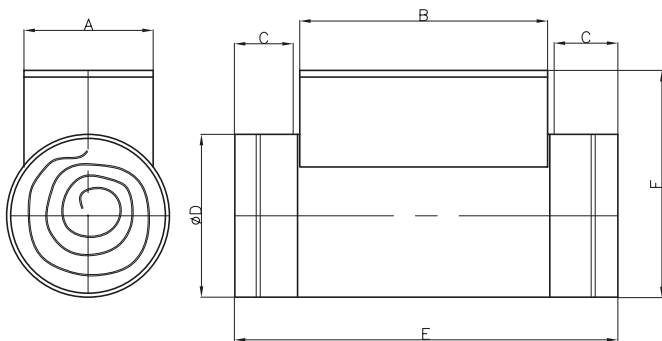

	CODE	A	B	C	ØD	E	F	KG
ELECTRIC HEATER 500 E	21631	125	300	50	121	400	223	3.6
ELECTRIC HEATER 1200 E	21632	125	300	50	121	400	223	3.8
ELECTRIC HEATER 1800 E	21633	125	300	50	121	400	223	4.0
ELECTRIC HEATER 500	21630	160	300	50	121	400	223	3.6
ELECTRIC HEATER 750	22735	151	300	50	146	400	247	4.0
ELECTRIC HEATER 1200	21622	161	300	50	156	400	245	4.4
ELECTRIC HEATER 2400	21623	161	300	50	156	400	245	4.9

Dimensions in mm

## TECHNICAL DATA

	CODE	(KW)	NO. OF PHASES	NO. OF SECTIONS	(A)	(V)	(HZ)	(IP)
ELECTRIC HEATER 500 E	21631	0.5	1	1/1	2.2	220-240	50/60	40
ELECTRIC HEATER 1200 E	21632	1.2	1	1/1	5.22	220-240	50/60	40
ELECTRIC HEATER 1800 E	21633	1.8	1	1/1	7.8	220-240	50/60	40
ELECTRIC HEATER 500	21630	0.5	1	1/1	2.2	220-240	50/60	40
ELECTRIC HEATER 750	22735	0.75	1	1/1	3.3	220-240	50/60	40
ELECTRIC HEATER 1200	21622	1.2	1	2/2	13	220-240	50/60	40
ELECTRIC HEATER 2400	21623	2.4	1	1/1	4.3	220-240	50/60	40

# NOISE ATTENUATOR

Attenuator to be installed in the ventilation system always after the fan and/or the filter box and/or the heater in the duct. Useful when a particularly low noise level is required.



- Operating temperature from -30 °C to +60 °C.
- Maximum operating pressure: 2000 Pa.
- Maximum air speed: 25 m/s.
- Internal pipe made with spiral of perforated aluminium sheet, 0.1 mm thick.
- PE film containment heads.
- Wool insulation, 40-mm thick basalt. Heat resistance R = 1.00 m<sup>2</sup>k/W.
- External spiral pipe in aluminum sheet, 0.1 mm thick.

## DIMENSIONS

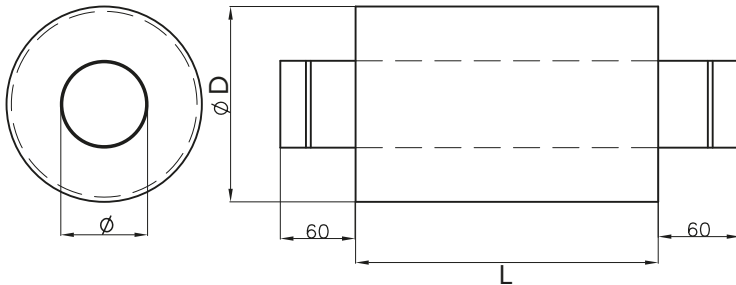

	CODE	Ø	ØD	L	KG
NA 160	21425	260	160	1000	9.1
NA 315	21428	415	315	1000	15.2

Dimensions in mm

## Graph to calculate pressure losses

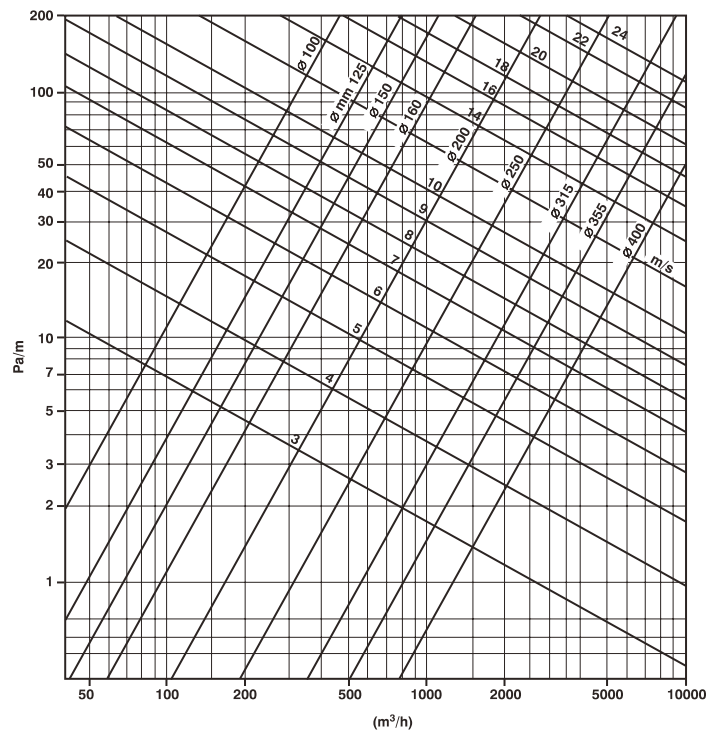



# BATTERIES

HOT AND COLD

## HOT BATTERY

Hot water battery for duct.



### DIMENSIONS

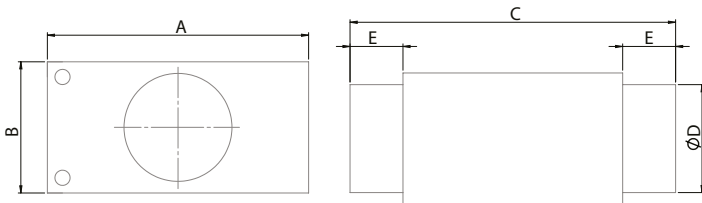

	CODE	A	B	C	ØD	KG
DHW 500 Ø 200	24148	465	320	700	200	4
DHW 800 Ø 250	24149	490	350	700	250	4.5
DHW 1500 Ø 315	24150	650	400	700	315	7.2
DHW 3000 Ø 350	24151	900	530	700	350	10
DHW 5000 Ø 450	24152	1180	740	700	450	17

Dimensions in mm

### HOT WATER BATTERY THERMAL YIELDS

**TABLE KEY:**

RH = Relative Humidity  
Q = Air flow rate

A iT = Air inlet temp  
A PΔ = Air pressure drop

A oT = Air outlet temp  
Pow. = Power

W q = Water flow rate  
W PΔ = Water pressure drops

#### DHW 500 - CODE 24148

AIR (70% RH)			WATER IN/OUT 80/70 °C				WATER IN/OUT 80/60 °C				WATER IN/OUT 60/40 °C				WATER IN/OUT 55/45 °C			
Q	A iT	A PΔ	A oT	Pow.	kW	W PΔ	A oT	Pow.	W q	W PΔ	A oT	Pow.	W q	W PΔ	A oT	Pow.	W q	W PΔ
m³/h	°C	Pa	°C	kW	m³/h	kPa	°C	kW	m³/h	kPa	°C	kW	m³/h	kPa	°C	kW	m³/h	kPa
430	-15	8	5.16	3.31	0.29	3.00	2.78	2.92	0.13	1.00	-2.84	2.92	0.09	0.01	-1.90	2.15	0.19	1.00
430	-10	8	9.10	3.08	0.27	3.00	6.79	2.71	0.12	1.00	1.35	1.83	0.08	0.01	2.17	1.96	0.17	1.00
430	-5	8	13.04	2.86	0.25	2.00	10.75	2.50	0.11	1.00	5.54	1.67	0.07	0.01	6.23	1.78	0.15	1.00
430	0	7	16.97	2.51	0.22	2.00	14.97	2.21	0.10	0.01	9.73	1.44	0.06	0.01	11.00	1.62	0.14	1.00
430	5	8	20.91	2.36	0.20	2.00	18.80	2.04	0.09	0.01	13.53	1.26	0.05	0.01	14.36	1.39	0.12	1.00
430	10	8	24.81	2.24	0.19	2.00	22.45	1.88	0.08	0.01	16.86	1.04	0.05	0.01	18.42	1.27	0.11	1.00

#### DHW 800 - CODE 24149

AIR (70% RH)			WATER IN/OUT 80/70 °C				WATER IN/OUT 80/60 °C				WATER IN/OUT 60/40 °C				WATER IN/OUT 55/45 °C			
Q	A iT	A PΔ	A oT	Pow.	kW	W PΔ	A oT	Pow.	W q	W PΔ	A oT	Pow.	W q	W PΔ	A oT	Pow.	W q	W PΔ
m³/h	°C	Pa	°C	kW	m³/h	kPa	°C	kW	m³/h	kPa	°C	kW	m³/h	kPa	°C	kW	m³/h	kPa
800	-15	20	9.01	7.34	0,631	16.0	6.51	6.57	0,283	4.00	0.57	4.76	0,205	2.00	1.60	5.07	0,436	8.00
800	-10	20	12.84	6.85	0,589	14.0	10.33	6.10	0,262	3.00	4.33	4.30	0,185	2.00	5.42	4.62	0,398	7.00
800	-5	20	16.63	6.37	0,548	12.0	13.04	5.32	0,229	3.00	8.06	3.85	0,166	1.00	9.23	4.19	0,361	6.00
800	0	18	20.97	5.76	0,496	10.0	18.37	5.05	0,217	2.00	12.13	3.33	0,143	1.00	13.04	3.58	0,308	4.00
800	5	19	24.10	5.45	0,469	9.0	20.91	4.54	0,195	2.00	15.29	2.94	0,126	1.00	16.63	3.32	0,286	4.00
800	10	19	27.78	5.00	0,430	8.0	24.85	4.17	0,179	2.00	19.11	2.56	0,110	1.00	20.28	2.89	0,248	3.00





## COLD BATTERY

Attenuator to be installed in the ventilation system always after the fan and/or the filter box and/or the heater in the duct. Useful when a particularly low noise level is required.



### DIMENSIONS

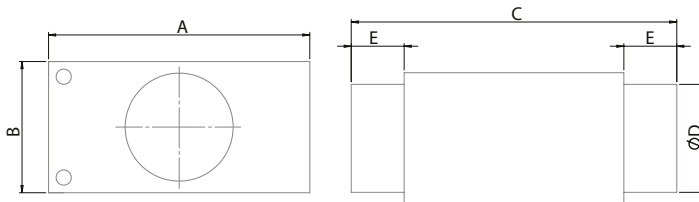

	CODE	A	B	C	ØD	E	KG
DCW 250 Ø 150	24146	-	-	-	150	-	-
DCW 500 Ø 200	24153	465	320	700	200	150	8.5
DCW 800 Ø 250	24154	520	350	700	250	150	10.8
DCW 1500 Ø 315	24155	655	405	700	315	150	18
DCW 3000 Ø 350	24156	900	540	700	350	150	23.4
DCW 5000 Ø 450	24157	1250	740	700	450	150	43

Dimensions in mm

## COLD WATER BATTERY THERMAL YIELDS

### TABLE KEY:

RH = Relative Humidity

A iT = Air inlet temp

A oT = Air outlet temp

W q = Water flow rate

Q = Air flow rate

A PΔ = Air pressure drop

Pow. = Power

W PΔ = Water pressure drops

### DCW 250 - CODE 24146

AIR (80% RH)			WATER IN/OUT 7/12 °C					WATER IN/OUT 55/45 °C				
Q m³/h	A iT °C	A PΔ Pa	A oT °C	Pow. kW	kW m³/h	W PΔ kPa	condensate l/h	A oT °C	Pow. kW	Q w m³/h	W PΔ kPa	condensate l/h
300	25	38	17.1	1.84	0.32	18.6	1.5	20.9	0.90	0.16	4.9	0.7
300	30	43	19.9	2.65	0.45	35.7	2.4	23.6	1.74	0.30	16.2	1.6
250	25	28	16.6	1.65	0.28	14.5	1.4	20.6	0.79	0.16	3.8	0.6
250	30	32	19.2	2.38	0.41	29.8	2.1	23.3	1.54	0.30	13.2	1.4
200	25	20	16.0	1.40	0.24	10.8	1.2	20.4	0.67	0.14	2.9	0.5
200	30	23	18.5	2.05	0.35	22.1	1.8	22.6	1.34	0.27	9.8	1.2
150	25	13	15.2	1.16	0.20	7.7	0.9	19.9	0.54	0.12	1.7	0.4
150	30	15	17.4	1.69	0.29	15.5	1.5	21.9	1.10	0.23	6.8	1.0
100	25	6	14.0	0.86	0.15	4.5	0.7	19.3	0.39	0.07	1.1	0.3
100	30	8	16.0	1.26	0.22	9.2	1.2	20.9	0.82	0.14	3.8	0.7

### DCW 500 - CODE 24153

AIR (50% RH)			WATER IN/OUT 7/12 °C				AIR (70% RH)			AIR (70% RH)				WATER IN/OUT 55/45 °C			
Q m³/h	A iT °C	A PΔ Pa	A oT °C	Pow. kW	kW m³/h	W PΔ kPa	W m³/h	A iT °C	A PΔ Pa	A oT °C	Pow. kW	W q m³/h	W PΔ kPa	A oT °C	Pow. kW	W q m³/h	W PΔ kPa
430	25	30	16.54	1.48	0.26	3.00	430	-10	24	25.85	5.78	0.25	2.00	26.54	5.89	0.51	7.00
430	30	34	19.04	2.51	0.43	7.00	430	0	21	30.62	4.52	0.19	1.00	31.71	4.68	0.40	5.00
430	35	34	21.46	3.83	0.66	14.00	430	10	22	34.36	3.68	0.18	1.00	34.96	3.77	0.32	3.00

# BATTERIES

HOT AND COLD

## COLD WATER BATTERY THERMAL YIELDS

**TABLE KEY:**

RH = Relative Humidity

A iT = Air inlet temp

A oT = Air outlet temp

W q = Water flow rate

Q = Air flow rate

A PΔ = Air pressure drop

Pow. = Power

W PΔ = Water pressure drops

**DCW 800 - CODE 24154**

AIR (50% RH)			WATER IN/OUT 7/12 °C				AIR (70% RH)			AIR (70% RH)				WATER IN/OUT 55/45 °C			
Q	A iT	A PΔ	A oT	Pow.	kW	W PΔ	W	A iT	A PΔ	A oT	Pow.	W q	W PΔ	A oT	Pow.	W q	W PΔ
m³/h	°C	Pa	°C	kW	m³/h	kPa	°m³/h	°C	Pa	°C	kW	m³/h	kPa	°C	kW	m³/h	kPa
800	25	47	16.96	2.64	0.45	9.00	800	-10	36	24.10	10.23	0.44	7.00	24.92	10.47	0.90	0.90
800	30	52	19.63	4.44	0.76	22.00	800	0	32	29.12	8.00	0.34	4.00	29.43	8.43	0.73	0.73
800	35	53	22.31	6.68	1.15	45.00	800	10	33	32.86	6.31	0.27	3.00	33.67	6.54	0.56	0.56

**DCW 1500 - CODE 24155**

AIR (50% RH)			WATER IN/OUT 7/12 °C				AIR (70% RH)			AIR (70% RH)				WATER IN/OUT 55/45 °C			
Q	A iT	A PΔ	A oT	Pow.	kW	W PΔ	W	A iT	A PΔ	A oT	Pow.	W q	W PΔ	A oT	Pow.	W q	W PΔ
m³/h	°C	Pa	°C	kW	m³/h	kPa	°m³/h	°C	Pa	°C	kW	m³/h	kPa	°C	kW	m³/h	kPa
1200	25	46	16.02	4.36	0,751	10.00	1200	-10	38	27.60	16.92	0,728	7.00	28.17	17.17	1,477	26.00
1200	30	49	18.29	7.27	1,251	24.00	1200	0	33	32.23	13.28	0,571	5.00	32.29	13.31	1,145	17.00
1200	35	48	20.56	10.79	1,856	49.00	1200	10	35	35.23	10.63	0,457	3.00	35.95	10.93	0,940	12.00
1800	25	94	17.18	5.48	0,943	15.00	1800	-10	76	22.35	21.84	0,939	12.00	23.29	22.47	1,932	42.00
1800	30	102	19.94	9.05	1,556	36.00	1800	0	67	27.73	17.14	0,737	8.00	28.17	17.42	1,498	27.00
1800	35	100	22.66	13.48	2,318	73.00	1800	10	71	31.75	13.75	0,591	5.00	32.59	14.27	1,228	19.00

**DCW 3000 - CODE 24156**

AIR (50% RH)			WATER IN/OUT 7/12 °C				AIR (70% RH)			AIR (70% RH)				WATER IN/OUT 55/45 °C			
Q	A iT	A PΔ	A oT	Pow.	kW	W PΔ	W	A iT	A PΔ	A oT	Pow.	W q	W PΔ	A oT	Pow.	W q	W PΔ
m³/h	°C	Pa	°C	kW	m³/h	kPa	°m³/h	°C	Pa	°C	kW	m³/h	kPa	°C	kW	m³/h	kPa
2500	25	59	16.74	8.29	1.43	4.00	2500	-10	45	26.67	29.16	1.25	2.00	28.51	30.86	2.65	9.00
2500	30	66	19.35	13.98	2.41	10.00	2500	0	41	29.23	25.10	1.08	2.00	30.92	26.55	2.28	7.00
2500	35	67	21.92	21.26	3.66	21.00	2500	10	42	33.11	19.94	0.86	1.00	34.17	20.86	1.79	5.00
3000	25	81	17.25	9.17	1.58	5.00	3000	-10	62	25.04	33.20	1.43	3.00	25.73	33.96	2.92	11.00
3000	30	92	20.07	15.36	2.64	12.00	3000	0	56	27.73	28.57	1.23	2.00	29.20	30.09	2.59	9.00
3000	35	94	22.84	23.41	4.03	24.00	3000	10	57	31.86	22.64	0.97	2.00	33.05	23.87	2.05	6.00

**DCW 5000 - CODE 24157**

AIR (50% RH)			WATER IN/OUT 7/12 °C				AIR (70% RH)			AIR (70% RH)				WATER IN/OUT 55/45 °C			
Q	A iT	A PΔ	A oT	Pow.	kW	W PΔ	W	A iT	A PΔ	A oT	Pow.	W q	W PΔ	A oT	Pow.	W q	W PΔ
m³/h	°C	Pa	°C	kW	m³/h	kPa	°m³/h	°C	Pa	°C	kW	m³/h	kPa	°C	kW	m³/h	kPa
4000	25	34	15.48	16.25	2.80	7.00	4000	-10	27	30.49	60.73	2.61	5.00	30.95	61.43	5.28	18.00
4000	30	37	17.64	27.27	4.69	18.00	4000	0	23	33.73	46.34	1.99	3.00	34.91	47.96	4.12	12.00
4000	35	37	19.80	40.81	7.02	38.00	4000	10	25	38.86	37.72	1.62	2.00	37.55	38.69	3.33	8.00
5000	25	51	16.16	18.45	3.17	9.00	5000	-10	39	27.60	70.50	3.03	7.00	28.17	71.56	6.15	24.00
5000	30	55	18.57	30.97	5.33	23.00	5000	0	34	32.07	55.08	2.37	4.00	32.29	55.46	4.77	15.00
5000	35	56	21.00	46.41	7.98	47.00	5000	10	36	35.11	44.08	1.90	3.00	35.30	44.41	3.82	10.00
6000	25	66	16.60	20.06	3.45	11.00	6000	-10	51	25.80	77.86	3.35	8.00	26.45	79.27	6.82	29.00
6000	30	73	19.18	33.61	5.78	27.00	6000	0	44	30.50	60.76	2.61	5.00	30.92	61.60	5.30	18.00
6000	35	73	21.80	50.28	8.65	54.00	6000	10	46	33.98	48.02	2.07	3.00	34.17	48.40	4.16	12.00

**NOTES**

---

---

---

---

---

---

---

---

---

---

---

---

---

---

---

---

---

---

---

---

---

---

---

---

---

# REMOTE CONTROL PANEL

## CB TOUCH LCD W Code 21933

Remote control panel with colour LCD graphic display which can be combined with VORTICE centralised residential heat recovery units.



### VORTICE COMPATIBLE RECOVERY UNITS:

- VORT HR 350 AVEL Code 12106  
VORT HR 300 NETI Code 10935  
VORT HR 450 AVEL D Code 12101
- VORT INVISIBLE MINI TOP Code 12214  
VORT HRI 200 PHANTOM BP Code 11291  
VORT HRI 350 PHANTOM BP Code 11293

134

### TECHNICAL FEATURES:

---

- Colour touch display with 4.5" screen.
- Wall fixing plate without need for standard electrical boxes.
- Connection with the heat recovery unit via port at extra low safety voltage (maximum length of the cable: 70 metres).
- Screen brightness which can be adjusted by the user to 3 different levels of intensity.
- Time-out display which can be set to 30, 60, and 120 seconds.
- Night light located on the lower part of the control panel which can be adjusted by the user to 4 levels of luminous intensity.
- Management software available in 6 languages: Italian, English, French, German, Spanish, and Chinese.
- Safety TUV SUD certified.

### DIMENSIONS

---

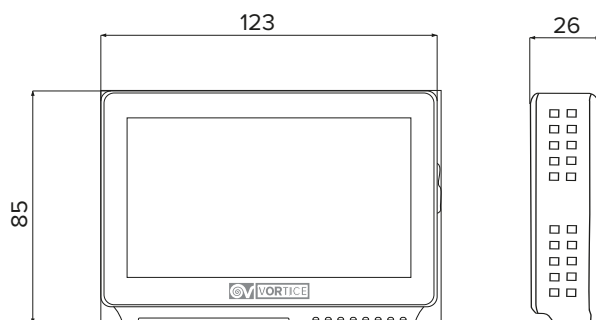

Dimensions in mm

## FEATURES AND SETTINGS

- Switching on/off of the controlled mechanical ventilation unit.
- Initial setting protected by password whose access is reserved for the installer.
- Manual selection of the operating speed (MANUAL MODE).
- Activation of the AUTO MODE: the product automatically regulates its operation based on the weekly schedule previously set.
- Activation of the BOOST MODE: the product goes at maximum speed.
- Activation of the QUIET MODE: the product never operates at the maximum speed during the night time band, which can be set by the user.
- Activation of the HOLIDAY MODE: the unit continuously operates at a reduced temperature so as to guarantee adequate air exchange even if there are no people in the house for a prolonged period of time.
- Setting of the weekly schedule of operation for the controlled mechanical ventilation unit.
- Manual activation of the by-pass damper.
- Activation/exclusion of the pre-heating/post-heating batteries (if installed).
- Display of the following values:
  - a. INDOOR and OUTDOOR air temperature (°C/°F)
  - b. Relative humidity (RH) in the environment.
- Display of the correct activation of the defrosting procedure in case of extremely cold temperatures.
- Monitoring of the correct operation of the controlled mechanical ventilation unit: any malfunctions are highlighted through error messages shown on the display.
- Signalling of the filter clogging status for a correct periodic maintenance.

**Note:** The features and display data mentioned above may vary depending on the controlled mechanical ventilation unit with which the CB LCD TOUCH W control panel is combined.

## INSTALLATION

Use the supplied screws and dowels to fix the rear plate to the wall

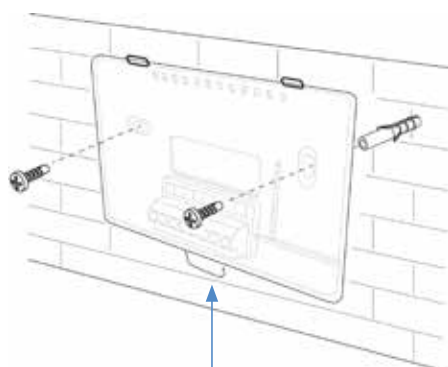

Recommended installation height = 1.50 m

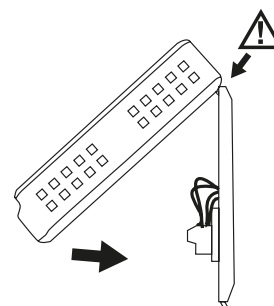

To mount the display correctly, align the two protrusions on the top part of the plate with the holes on the back of the display.

# REGULATORS AND CONTROLLERS

## REGULATORS

Control box

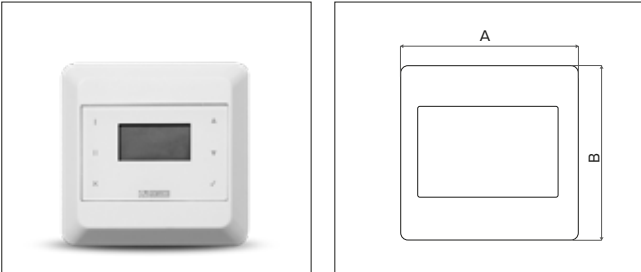

	CODE	A	B
CB LCD D	21381	85	85

Remote control unit with wired LCD panel, for recessed installation.

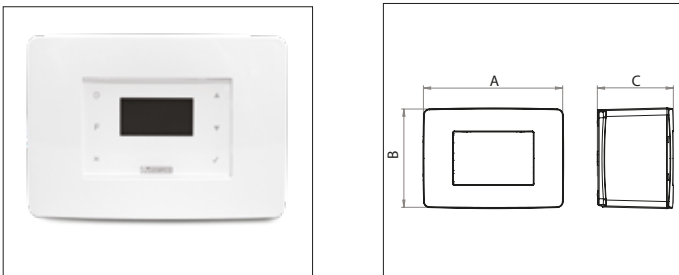

	CODE	A	B	C
CB LCD R	21194	116	83	29

Wall box for housing the control unit.



	CODE
WALL HRW RC BOX	22732

Remote control unit with wired LCD panel, for wall installation.

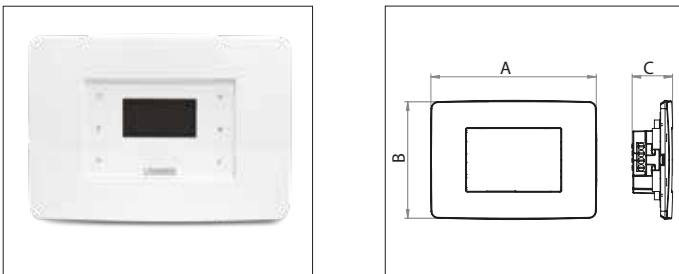

	CODE	A	B	C
CB LCD W	21195	116	83	65

Recessed box type 503 for housing the control unit.



	CODE
RECESSED BOX TYPE 503	22461



## REGULATORS

Installer panel.



	CODE
SKP10 INSTALLER PANEL	22629

Radio frequency remote control with large display is the only command/control instrument of VORT PROMETEO PLUS HR 400; each function is activated, regulated and monitored through it.



	CODE
VORT HR 400 PLUS REMOTE CONTROL	22464

External module



	CODE
EXTERNAL RF MODULE	22479

Wired remote control unit (maximum distance from the unit 50 m) with LCD display for VORT HR 550 AVEL heat recovery unit. Vertical recessed installation in a standard 503 box. The interface, functions, keys etc. do not differ from the control unit installed in the machine.

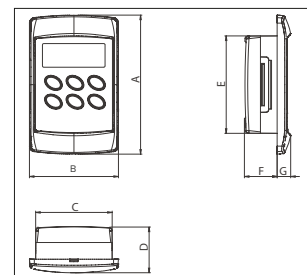

	CODE	A	B	C	D	E	F	G
TAL	21602	100	64	55	32.8	70	23.5	9.7

Wired remote control unit (maximum distance from the unit 150 m) with color LCD touch display for VORT HR 550 AVEL heat recovery unit. Wall or recessed installation in SI TNF box.

137

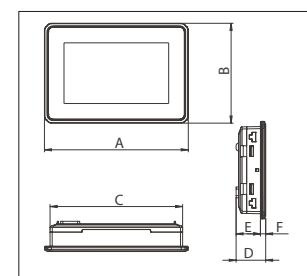

	CODE	A	B	C	D	E	F
TNF	21603	134	93	123.5	28.1	23.1	5

Recessed box, complete with brackets for fixing on plasterboard walls, for housing the TNF remote control panel.

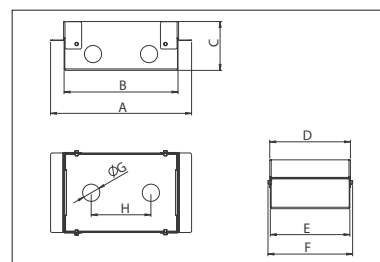

	CODE	A	B	C	D	E	F	ØG	H
SI TNF	21604	156	126	54	89.2	88	93.6	19	66

# REGULATORS AND CONTROLLERS

## REGULATORS

Control panel with LCD display for remote control (wired connection) of the VORT HRI DH series heat recovery units.

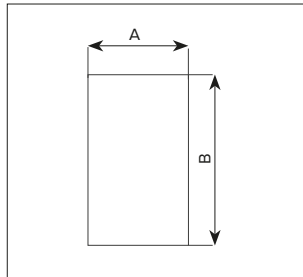

	CODE	A	B
RCP (HRI DH)	22607	62	102

Electronic thermo-hygrostat for VORT HRI 260 DH and VORT HRI 500 DH heat recovery units. To be installed in the relevant room at a height between 1.2 and 1.5 m from the floor and at a maximum distance of 20 m from the combined heat recovery unit.

138

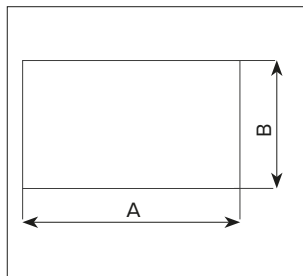

	CODE	A	B
ETRH (HRI DH)	22608	120	80

Mechanical hygrostat for VORT HRI 260 DH RC and VORT HRI 500 DH RC heat recovery units. To be installed in the relevant room at a height between 1.2 and 1.5 m from the floor.

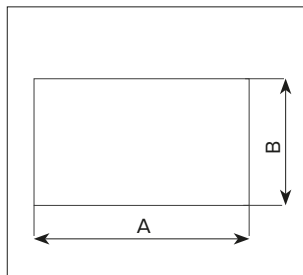
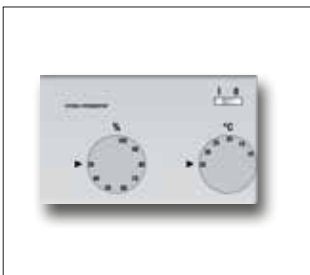

	CODE	A	B
MTRH (HRI DH)	22609	127	75

## SENSORS

### TEMPERATURE DETECTOR

Controls the ambient air temperature: the fan is automatically activated when it detects an adjustable temperature with an external trimmer from 10° to 40° higher than the set threshold value.

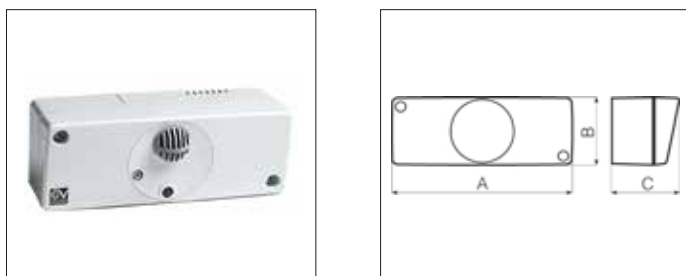

	CODE	A	B	C
C TEMP	12992	144	54	55.8

### PRESENCE DETECTOR

Checks for the presence of people in the environment: the fan is automatically activated when it detects the presence of a person within its range.

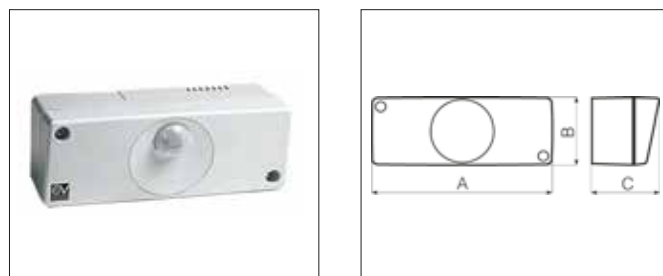

	CODE	A	B	C
C PIR	12998	144	54	55.8

### POLLUTED AIR DETECTOR

Controls the air quality in the presence of cigarette smoke, odours, and other pollutants: the extractor fan is automatically activated when it detects an odour concentration higher than the set value adjustable with an external trimmer.

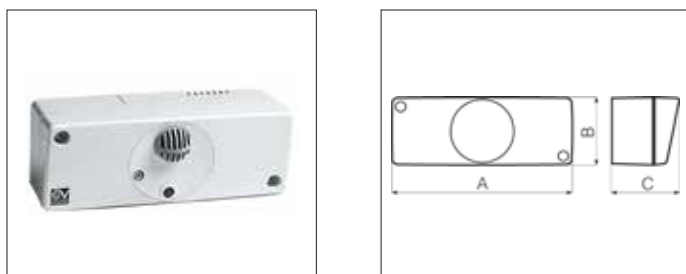

	CODE	A	B	C
C SMOKE	12993	144	54	55.8

### HUMIDITY DETECTOR

Checks the relative humidity of the air: the extractor fan is automatically activated when the percentage of relative humidity exceeds 65%.

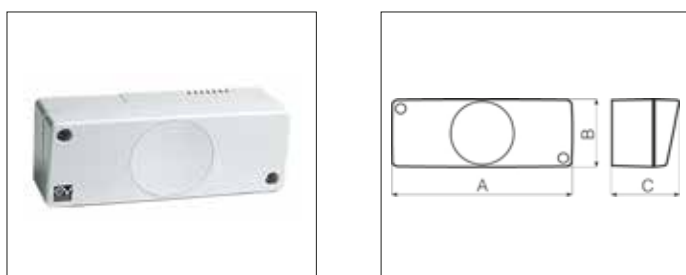

	CODE	A	B	C
C HCS	12994	144	54	55.8

### TIMER

Controls the operating time of the product to which it is connected: the extractor fan is automatically activated a few seconds after the light is turned on and continues to operate for a preset time, adjustable with an internal trimmer from 3 to 20 minutes, after the light is turned off.

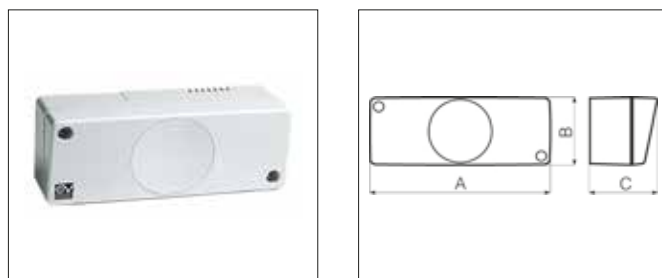

	CODE	A	B	C
C TIMER	12999	144	54	55.8









## VORTICE GROUP COMPANIES

### VORTICE S.P.A

Strada Cerca, 2  
Frazione di Zoate  
20067 Tribiano  
(Milan) Italy  
Tel. (+39) 02 906991  
Fax (+39) 02 90699625  
vortice.com

### VORTICE LIMITED

Beeches House  
Eastern Avenue  
Burton on Trent  
DE13 0BB United Kingdom  
Tel. (+44) 1283-49.29.49  
Fax (+44) 1283-54.41.21  
vortice.ltd.uk

### VORTICE INDUSTRIAL S.R.L.

Via B. Brugnoli 3,  
37063 Isola della Scala  
(Verona) Italy  
Tel. (+39) 045 6631042  
Fax (+39) 045 6631039  
vorticeindustrial.com

### CASALS VENTILACIÓN AIR INDUSTRIAL S.L.

Ctra. Camprodon, s/n 17860  
Sant Joan de les Abadesses  
(Girona) Spain  
Tel. (+34) 972720150  
casals.com

### VORTICE LATAM S.A.

Bodega #6  
Zona Franca Este Alajuela,  
Alajuela 20101  
Costa Rica  
Tel. (+506) 2201 6934  
vortice-latam.com

### VORTICE VENTILATION SYSTEM

(Changzhou) Co.LTD  
No. 388 West Huanghe Road  
Building 19, Changzhou  
Post Code: 213000 China  
Tel. (+86) 0519 88990150  
Fax (+86) 0519 88990151  
vortice-china.com

### TOLL-FREE NUMBER

**800 555 777**

The descriptions and illustrations in this catalogue are intended to be indicative and not binding. Without prejudice to the essential characteristics of the products described and illustrated here, VORTICE reserves the right to make, at any time and without notice, any changes to parts, aesthetic details or supply of accessories to its products that are deemed to be appropriate for improvement or for any construction or commercial requirement.  
This printout completely cancels and replaces all previous ones.

